

Thank you for purchasing a Sealey quality product. Manufactured to a high standard this product will, if used according to these instructions and properly maintained, give you years of trouble free performance.



**IMPORTANT**

**BEFORE USING THIS PRODUCT, PLEASE READ THE INSTRUCTIONS CAREFULLY. MAKE CAREFUL NOTE OF SAFETY INSTRUCTIONS, WARNINGS AND CAUTIONS. THIS PRODUCT SHOULD ONLY BE USED FOR ITS INTENDED PURPOSE. FAILURE TO DO SO MAY CAUSE DAMAGE AND/OR PERSONAL INJURY AND WILL INVALIDATE THE WARRANTY. KEEP THESE INSTRUCTIONS SAFE.**

## 1. SAFETY INSTRUCTIONS

### 1.1. ELECTRICAL SAFETY

**WARNING!** It is the responsibility of the owner and the operator to read, understand and comply with the following:

You must check all electrical products, before use, to ensure that they are safe. You must inspect power cables, plugs, sockets and any other connectors for wear or damage. You must ensure that the risk of electric shock is minimised by the installation of appropriate safety devices. A Residual Current Circuit Breaker (RCCB) should be incorporated in the main distribution board. We also recommend that a Residual Current Device (RCD) is used. It is particularly important to use an RCD with portable products that are plugged into a supply which is not protected by an RCCB. If in any doubt consult a qualified electrician. You may obtain a Residual Current Device by contacting your Sealey dealer. **You must** also read and understand the following instructions concerning electrical safety.

- 1.1.1. The **Electricity at Work Act 1989** requires all portable electrical appliances, if used on business premises, to be tested by a qualified electrician, using a Portable Appliance Tester (PAT), at least once a year.
- 1.1.2. The **Health & Safety at Work Act 1974** makes owners of electrical appliances responsible for the safe condition of those appliances and the safety of the appliance operators. **If in any doubt about electrical safety, contact a qualified electrician.**
- 1.1.3. Ensure that the insulation on all cables and on the appliance is safe before connecting it to the power supply. See 1.1.1. and 1.1.2. and use a Portable Appliance Tester.
- 1.1.4. Ensure that cables are always protected against short circuit and overload.
- 1.1.5. Regularly inspect power supply cables and plugs for wear or damage and check all connections to ensure that none is loose.
- 1.1.6. **Important:** Ensure that the voltage marked on the appliance matches the power supply to be used and that the plug is fitted with the correct fuse - see fuse rating at right.
- 1.1.7. **DO NOT** pull or carry the appliance by the power cable.
- 1.1.8. **DO NOT** pull the plug from the socket by the cable.
- 1.1.9. **DO NOT** use worn or damaged cables, plugs or connectors. Immediately have any faulty item repaired or replaced by a qualified electrician. When an ASTA/BS approved UK 3 pin plug is damaged, cut the cable just above the plug and **dispose of the plug safely**. Fit a new plug according to the following instructions (UK only).
  - a) **Connect the GREEN/YELLOW earth wire to the earth terminal 'E'.**
  - b) **Connect the BROWN live wire to the live terminal 'L'.**
  - c) **Connect the BLUE neutral wire to the neutral terminal 'N'.**
  - d) **After wiring, check that there are no bare wires, that all wires have been correctly connected, that the cable outer insulation extends beyond the cable restraint and that the restraint is tight.**

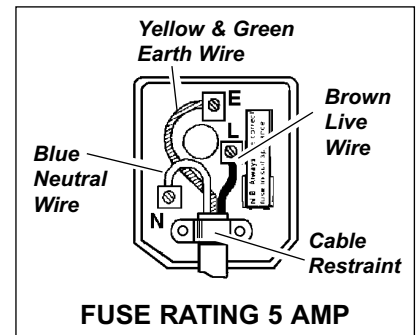

Double insulated products, which are always marked with this symbol , are fitted with live (brown) and neutral (blue) wires only. To rewire, connect the wires as indicated above - **DO NOT** connect either wire to the earth terminal.

- 1.1.10. Products which require more than 13 amps are supplied without a plug. In this case you must contact a qualified electrician to ensure that a suitable rated supply is available. We recommend that you discuss the installation of an industrial round pin plug and socket with your electrician.
- 1.1.11. If an extension reel is used it should be fully unwound before connection. A reel with an RCD fitted is preferred since any appliance plugged into it will be protected. The cable core section is important and should be at least 1.5mm<sup>2</sup>, but to be absolutely sure that the capacity of the reel is suitable for this product and for others which may be used in the other output sockets, we recommend the use of 2.5mm<sup>2</sup> section cable. If extension reel is to be used outdoors, ensure it is marked for outdoor use.

### 1.2. GENERAL SAFETY

- WARNING!** Disconnect the bandsaw from the power source before servicing, changing accessories or performing any other maintenance.
- ✓ Familiarise yourself with applications and limitations of the product, as well as the potential hazards.
- ✓ Maintain the bandsaw in good condition. Keep it clean and keep blades sharp for best and safest performance.
- ✓ Use original Sealey spare parts only. Unapproved parts may be dangerous and will invalidate the warranty.
- ✓ Keep all guards and fixing screws in place, tight and in working order. Check regularly for damaged parts. A guard or any other part that is damaged must be repaired or replaced before the saw is used further. Check also the alignment of moving parts, loose mountings, or any other condition that could affect the operation of the saw.
- ✓ Ensure that the space allocated for use and maintenance of the machine is adequate, free from unrelated materials and has good lighting.
- ✓ Remove any adjusting keys and wrenches from the machine before operating.
- ✓ Wear approved eye and ear protection when operating the machine. If dust is produced, wear an approved face or dust mask.
- ✓ Keep correct footing and balance at all times and wear non-slip shoes.
- ✓ Always secure the workpiece with a clamp or vice.
- ✓ Keep children and unauthorised persons away from the work area, especially when the saw is in operation.
- ✓ Ensure that large or oversize workpieces are supported at table height. Ensure you use a suitable support for any workpiece that does not have a flat surface. Be cautious when cutting workpieces which are irregular in cross-section. The saw blade could be pinched before the cut is completed. Any stock such as frame moulding, must lay flat on the table surface and not be allowed to rock.
- WARNING!** Rods and tubing have a tendency to roll while being cut, causing the blade to "bite". **DO NOT** cut such items without first clamping or blocking the workpiece.
- WARNING!** Never force the blade through the workpiece.
- X** Do not use this machine for anything other than its intended purpose. The machine is designed for light metal cutting work in engineering workshops, garages, metal fabricators, etc.

- ❑ **WARNING!** The SM65.V2 bandsaw **MUST NOT** be used to cut **non-metallic materials** (including wood) as to do so will invalidate your insurance cover and your warranty and may cause damage and/or personal injury.
- ✗ Do not wear loose or ill-fitting clothing. Remove ties, watches, rings and other jewellery. Tie up, or adequately cover, long hair.
- ✗ Do not start the machine until the workpiece is secure and the blade has been lowered to just above the workpiece.
- ✗ Do not use the bandsaw with the blade guard or pulley cover removed.
- ✗ Do not use damaged or deformed blades.
- ✓ Turn the saw off **before** raising the blade.
- ✗ Do not run the saw with the blade in the raised position.
- ✗ Do not use the machine in wet or damp locations.
- ✗ Do not use the machine in areas where fumes from paint, solvents, or flammable liquids pose a potential hazard. Keep all flammable materials (including wipers or cleaning rags) away from the saw, and dispose of according to local regulations.
- ✗ Do not stand on the machine.
- ✗ Do not leave machine running unattended. Turn power switch 'Off' and do not leave area until machine has come to a complete stop.
- ✗ Do not use whilst under the influence of drugs, alcohol or other intoxicating medication. Do not use the tool if you are tired.

## 2. INTRODUCTION & SPECIFICATION

### 2.1. Introduction

The SM65.V2 complies with requirements of the Machinery Safety Directive 98/37/EC and is fully CE approved. The machine has a heavy duty cast base and a swivel arm with a fully guarded blade for the cutting of light metals. A magnetic no-load voltage switch prevents the motor from re-starting in the event of a power failure or a blade jam. An oil-bath gear box and sealed-for-life drive bearings give fast and smooth operation. Fully adjustable precision blade guides provide accuracy and long blade life. Supplied with anti-vibration feet and workshop stand.

### 2.2. Specification

Capacity 90° Round .....Ø105mm  
 Capacity 90° Square/Rectangle .....100 x 150mm  
 Capacity 45° Round .....Ø100mm  
 Capacity 45° Square/Rectangle .....85 x65mm  
 Blade Size .....12.7x0.7x1638mm

Blade Speeds .....0.3, 0.5, 0.8mtr/sec  
 Motor Power .....375W (1/2hp)  
 Power Supply .....230V/1ph  
 Weight.....62kg

## 3. ASSEMBLY AND SET-UP

### 3.1. Assembly

**Note:** Numbers in brackets refer to Fig 1 and Parts Diagram Items.

- 3.1.1. Assemble the floor stand as described below using the nuts and bolts provided (refer to Fig 1).
- 3.1.2. Make one end frame by assembling two legs (1) to short upper cross member (4) using four bolts (8), four washers (7), four split washers (6) and four nuts (5). Attach lower short cross member (3) to the inside of the legs using two bolts (8).
- 3.1.3. Create a second end frame using the same set of components.
- 3.1.4. Join the two end frames together using two long upper cross members (9) using two bolts (8) at each end of each cross member. The ends of the long cross members should pass under the ends of the short cross members (4).
- 3.1.5. Attach the two lower long cross members (2) to the inside of the frame using one bolt at the end of each.
- 3.1.6. The anti-vibration mountings (14) can either be fitted to the base of the saw or to the stand. For bench mounting and when the stand is to be secured to the floor, fit the mountings to the saw base. Where the stand is to be portable, fit the mountings to the bottom of the legs.
- 3.1.7. Place the saw onto the stand and retain it at either end with bolt (10), washer (11) and nut (12).
- 3.1.8. Remove transit chain (15), retain for future use.
- 3.1.9. Slide fence (104) into vice base (103) and tighten set screw in front face of vice to retain.
- 3.1.10. When the saw arm is in the down position the cutting edge of the blade should be just below the main surface of the vice in order for the blade to cut all the way through the workpiece. If this is not the case, loosen the lock nut (37) and adjust the stop bolt (38) so that the cutting edge of the blade is 2 to 3mm below the vice surface. Re-tighten locknut (37).
- 3.1.11. Adjust switch cut-off screw (17) to ensure that 'Off' switch is actuated when, or just before, the body frame contacts the abutment screw (38). Tighten nut (5).

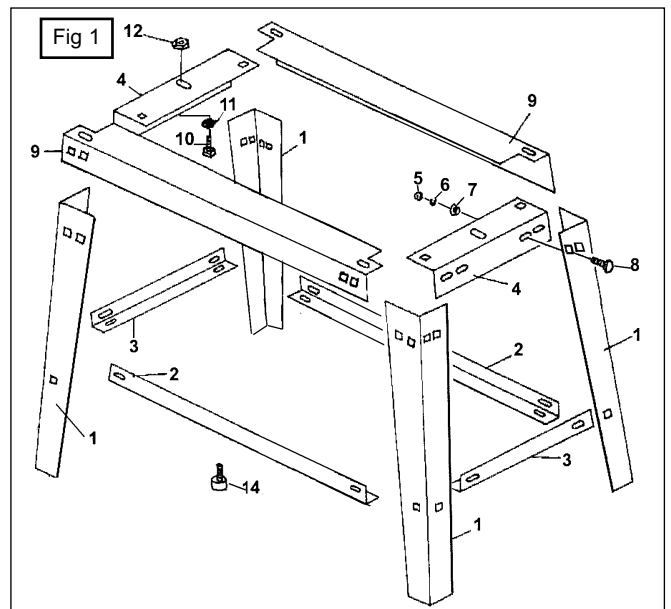

### 3.2. Blade selection

The chart at the right show the recommended setup for various metals and cut lengths. Blades are available from your Sealey dealer in four tooth pitches: 6, 10, 14 and 24 tpi (see parts list).

#### Blade Chart for Flat and Round Bar

Recommended blade teeth per inch (tpi) for nominal cut length.

Cut Length	Under 8mm	4-13mm	6-16mm	8-22mm
Tpi	32	24	18	14
Cut Length	10-35mm	17-40mm	25-50mm	38-75mm
Tpi	10	8	6	4
Cut Length	50-100mm	75-150mm	114-225mm	>200mm
Tpi	3	2	1.25	0.75

### 3.3. Adjusting blade speed

Adjust the blade speed to suit the metal to be cut. The recommended pulley selections are shown in the chart to the right.

- 3.3.1. Disconnect saw from power supply and open the pulley cover (52).
- 3.3.2. Loosen the motor securing nuts (12) on the motor plate to slacken the belt.
- 3.3.3. Move the belt to the required pulley grooves (see chart).
- 3.3.4. Tension belt and tighten nuts (12), close and secure the pulley cover using screw (30) and washer (7).

Recommended Pulley Selection for Various Metals			
Material	Motor Pulley	Blade Pulley	Blade Speed
Tool, stainless or alloy steel. Bearing bronze.	Small (A)	Large (D)	20m/min
Low to medium carbon steel.	Medium (B)	Medium (E)	29m/min
Aluminium. Copper. Brass.	Large (C)	Small (F)	50m/min

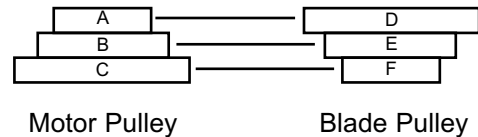

## 4. OPERATION

- ❑ **WARNING! Before operating the bandsaw ensure that you read, understand and apply the safety instructions in Section 1.**  
**NOTE: Before operating the machine certain checks and adjustments will need to be carried out. It is very important that these instructions are followed carefully in order that the machine is set up safely and correctly.**
- ❑ **WARNING! The machine is designed for the cutting of light metal in engineering workshops, garages, metal fabricators, etc. The SM65.V2 must not be used to cut any other materials (including wood). To do so will invalidate your insurance cover and your warranty and may cause damage and/or personal injury.**

Note: The harder the material being cut, the slower the cutting speed should be. The use of a cutting oil is recommended with the higher blade speeds.

### 4.1. Horizontal Cutting

- ❑ **WARNING! BEFORE MAKING ANY ADJUSTMENTS, DISCONNECT SAW FROM POWER SUPPLY.**

- 4.1.1. Adjust the blade speed to suit the workpiece (see para. 3.3).
- 4.1.2. Raise the saw arm as far as possible.
- 4.1.3. Adjust the stock stop rod (104) to the desired length.
- 4.1.4. Raise the handle of quick grip vice (103) to unlock and slide vice jaw. Insert workpiece against fixed jaw. Slide vice jaw up to workpiece and firmly press down vice handle to clamp it securely.
- 4.1.5. If an angled cut is required slacken lever nut (36). Rotate bevel holder (31) and saw arm to angle required and tighten lever nut (36).
- 4.1.6. Adjust the two blade guides, by slackening the knob (99) and the screw (43), so that they are close to the workpiece but will not foul it.
- 4.1.7. Gently lower the arm until the blade is just above the workpiece. Connect the saw to the power supply and start the saw.  
**DO NOT** turn on the machine until the workpiece is secured and the blade has been lowered to just above workpiece.
- 4.1.8. Bring the blade into contact with the workpiece and then release the arm. If the blade jams and the saw does not automatically shut off, immediately disconnect it from the power supply. Refer to the 'Troubleshooting' section for common problems.
- 4.1.9. When sawing is completed disconnect from the power supply, raise blade and remove workpiece.  
**Never raise the blade when the machine is running and never run the machine when the blade is raised.**

## 5. ADJUSTMENTS

- ❑ **WARNING! BEFORE MAKING ANY ADJUSTMENTS, DISCONNECT SAW FROM POWER SUPPLY.**

### 5.1. Blade tension

- 5.1.1. Disconnect the machine from the power supply and then remove blade cover.
- 5.1.2. Adjust the blade tension with knob (95) (fig.2.A), so that light thumb pressure on the blade midway between the blade wheels produces a deflection of approximately 1mm. **Do not over tighten.**
- 5.1.3. Replace blade cover, reconnect to power source and run for two to three minutes to seat the blade.
- 5.1.4. Disconnect saw from the power source, remove blade cover and recheck tension. Replace blade cover.

### 5.2. Blade guide bearing adjustment

- Correct guide bearing (fig.2.B) adjustment is important so that the blade runs smoothly and evenly without twisting or snagging anywhere. Each of the outer guide bearings is mounted on an adjustable eccentric bush.
- 5.2.1. Disconnect the machine from the power supply.
  - 5.2.2. Loosen the bearing pivot (59) lock nut (12) while holding the pivot, immediately above the bearing, with an open ended spanner.
  - 5.2.3. Turn the pivot to adjust the bearing. The bearing should barely touch the blade (0.001" clearance). Tighten the lock nut when satisfied with the bearing adjustment.
  - 5.2.4. Adjust both outer guide bearings.
  - 5.2.5. When satisfied that the adjustment is accurate, carefully turn the blade wheels by hand to see if the blade snags or rubs at any point. Readjust bearing(s) if necessary.

### 5.3. Blade guide adjustment

- 5.3.1. Disconnect the machine from the power supply.
- 5.3.2. Loosen hex bolt (fig.3.E) and pivot blade adjustment bracket (fig.3.F) until blade is perpendicular to vice bed (103).
- 5.3.3. Retighten the hex bolt (fig.3.E).

### 5.4. Replacing the saw blade

We recommend you keep a small supply of commonly used saw blades to hand. Change saw blades frequently for best results. Ensure you choose a blade with a pitch suitable for workpiece to be cut (see cutting chart, Section 3).

- ❑ **WARNING! Take care when handling saw blades, blade teeth are very sharp.**

- 5.4.1. Loosen the blade tension, move both front guide bearings away from blade (see para. 5.2.) and remove blade cover.
- 5.4.2. Carefully remove old blade and install new one ensuring that tooth direction is consistent with the blade travelling left-to-right in the cutting area.
- 5.4.3. Reset blade tension (see para. 5.1.), check tracking (see para. 5.5.), replace blade cover and adjust guide bearings (see para. 5.2.).

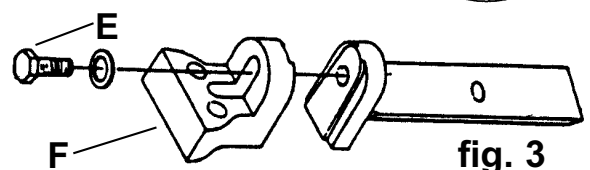
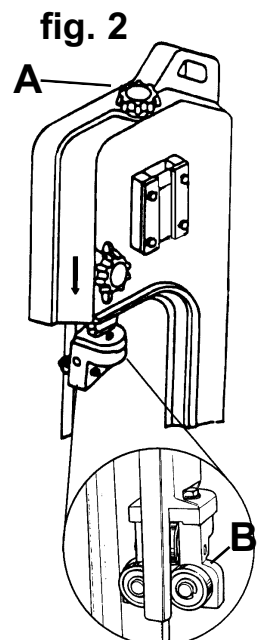

## 5.5. Blade tracking

Adjustment of the blade tracking is necessary to prevent the blade from twisting or coming off the blade wheels. This adjustment should be made whenever a new blade is fitted (see para. 5.4.).

- 5.5.1. Run saw for a short time and then switch off.
- 5.5.2. Raise saw arm, remove blade cover and check blade-to-wheel relationship (tracking). Rear edge of blade should be very close to, but not hard against, the wheel flanges.
- 5.5.3. If inspection indicates that adjustment is required reduce blade tension (see para. 5.1.) and loosen the set screw (65) in driven wheel (67).
- 5.5.4. Move drive wheel in or out on shaft as required to improve tracking and tighten set screw.
- 5.5.5. Having made a small adjustment, tension blade, **replace the blade cover, lower the arm** and run the saw for a short time.
- 5.5.6. Switch saw off, remove blade cover and check tracking. Repeat adjustment procedure if necessary.



## 6. MAINTENANCE

- 6.1. Clean saw after each operation and smear unpainted surfaces with oil to prevent rusting.
- 6.2. Annually replace gearbox oil (SAE 90) as follows:
  - 6.2.1. With blade arm horizontal remove gearbox cover screws (16), cover (78) and gasket (77).
  - 6.2.2. Place oil container under right hand lower corner of gearbox and then carefully raise saw arm fully to drain oil.
  - 6.2.3. Lower saw arm, remove any remaining oil from gearbox with clean cloths and then refill with fresh oil. Replace cover and gasket.

## 7. TROUBLESHOOTING

Excessive blade breakage and/or teeth ripping from the blade.	<ol style="list-style-type: none"> <li>1. Workpiece is loose in the vice.</li> <li>2. Incorrect speed or feed.</li> <li>3. Blade is too fine.</li> <li>4. Workpiece is too coarse.</li> <li>5. Incorrect blade tension.</li> <li>6. Blade is in contact with workpiece before saw is started.</li> <li>7. Blade is rubbing on the wheel flange.</li> <li>8. Blade guides are misaligned.</li> <li>9. Blade is too thick.</li> </ol>	<ol style="list-style-type: none"> <li>1. Clamp the workpiece securely.</li> <li>2. Adjust the speed or feed to suit the workpiece.</li> <li>3. Replace with a coarser blade.</li> <li>4. Use the saw at slower speed and use a smaller tpi blade.</li> <li>5. Adjust blade tension so that it does not slip on the wheel.</li> <li>6. Place blade in contact with the workpiece only after the saw has started.</li> <li>7. Adjust blade wheel alignment.</li> <li>8. Adjust blade guide alignment.</li> <li>9. Use correct thickness blade.</li> </ol>
Premature blade dulling.	<ol style="list-style-type: none"> <li>1. Blade tpi is too high.</li> <li>2. Incorrect speed - too fast.</li> <li>3. Inadequate feed pressure.</li> <li>4. Hard spots or scale on the workpiece.</li> <li>5. Blade is twisting.</li> <li>6. Insufficient blade tension.</li> <li>7. Blade is slipping.</li> </ol>	<ol style="list-style-type: none"> <li>1. Replace with a smaller tpi blade.</li> <li>2. Reduce speed.</li> <li>3. Increase feed pressure.</li> <li>4. Reduce speed, increase feed pressure.</li> <li>5. Replace blade and adjust to the correct tension.</li> <li>6. Increase blade tension.</li> <li>7. Increase blade tension and reduce speed.</li> </ol>
Unusual wear on side or back of blade.	<ol style="list-style-type: none"> <li>1. Blade guides are worn.</li> <li>2. Blade guides are misaligned.</li> <li>3. Blade guide brackets are loose.</li> </ol>	<ol style="list-style-type: none"> <li>1. Replace blade guides.</li> <li>2. Adjust guide pivots.</li> <li>3. Tighten blade guide brackets.</li> </ol>
Motor overheating.	<ol style="list-style-type: none"> <li>1. Blade tension too high.</li> <li>2. Drive belt tension too high.</li> <li>3. Blade too coarse or too fine.</li> <li>4. Gears need lubrication.</li> <li>5. Blade is binding in the cut.</li> </ol>	<ol style="list-style-type: none"> <li>1. Reduce blade tension.</li> <li>2. Reduce drive belt tension.</li> <li>3. Use a blade more suitable for the workpiece.</li> <li>4. Lubricate the gears.</li> <li>5. Decrease feed and speed.</li> </ol>
Bad, crooked or rough cuts.	<ol style="list-style-type: none"> <li>1. Feed pressure too great.</li> <li>2. Blade guides are misaligned.</li> <li>3. Inadequate blade tension.</li> <li>4. Blade is dull.</li> <li>5. Incorrect speed.</li> <li>6. Blade guides are spaced out too far.</li> <li>7. Blade guide assembly is loose.</li> <li>8. Blade is too coarse.</li> </ol>	<ol style="list-style-type: none"> <li>1. Reduce feed pressure.</li> <li>2. Adjust blade guides.</li> <li>3. Increase blade tension.</li> <li>4. Replace the blade.</li> <li>5. Adjust the speed.</li> <li>6. Adjust guide spacing.</li> <li>7. Tighten the guide assembly.</li> <li>8. Use a finer blade.</li> </ol>
Blade is twisting.	<ol style="list-style-type: none"> <li>1. Blade is binding in the cut.</li> <li>2. Blade tension is too high.</li> </ol>	<ol style="list-style-type: none"> <li>1. Reduce feed pressure.</li> <li>2. Decrease blade tension.</li> </ol>

## 8. DECLARATION OF CONFORMITY

<p><b>Metal Cutting Bandsaw</b>  <b>Model: SM65.V2</b>                      98/37/EC Machinery Directive                      73/23/EEC Low Voltage Directive                      89/336/EEC EMC Directive                      93/68/EEC CE Marking Directive</p>	<p><b>Declaration of Conformity</b> We, the sole importer into the UK, declare that the product listed here is in conformity with the following standards and directives.</p> <p> Signed by Mark Sweetman  15th August 2003</p> <p>The construction file for this product is held by the Manufacturer and may be inspected, by a national authority, upon request to Jack Sealey Ltd.</p> <p><i>For Jack Sealey Ltd. Sole importer into the UK of Sealey Quality Machinery.</i></p>
---	--

**NOTE:** It is our policy to continually improve products and as such we reserve the right to alter data, specifications and component parts without prior notice.

**IMPORTANT:** No liability is accepted for incorrect use of product. **WARRANTY:** Guarantee is 12 months from purchase date, proof of which will be required for any claim. **INFORMATION:** For a copy of our latest catalogue and promotions call us on 01284 757525 and leave your full name and address, including postcode.

	<p>Sole UK Distributor,                      Sealey Group,                      Bury St. Edmunds, Suffolk.</p>		
 01284 757500	 01284 703534	 sales@sealey.co.uk	 www.sealey.co.uk