



HEAVY-DUTY 2-IN-1 COMPACT RIVETER

MODEL NO: **AK3989**

Thank you for purchasing a Sealey product. Manufactured to a high standard, this product will, if used according to these instructions, and properly maintained, give you years of trouble free performance.

IMPORTANT: PLEASE READ THESE INSTRUCTIONS CAREFULLY. NOTE THE SAFE OPERATIONAL REQUIREMENTS, WARNINGS & CAUTIONS. USE THE PRODUCT CORRECTLY AND WITH CARE FOR THE PURPOSE FOR WHICH IT IS INTENDED. FAILURE TO DO SO MAY CAUSE DAMAGE AND/OR PERSONAL INJURY AND WILL INVALIDATE THE WARRANTY. KEEP THESE INSTRUCTIONS SAFE FOR FUTURE USE.



Refer to instructions



Wear eye protection

1. SAFETY

- WARNING!** Ensure Health & Safety, local authority and general workshop practice regulations are adhered to when using this tool.
- Familiarise yourself with the application and the limitations of the riveter, as well as the potential hazards.
- Maintain the riveter in good condition (use an authorised service agent).
- Replace or repair damaged parts. Use genuine parts only. Unauthorised parts may be dangerous and will invalidate the warranty.
- Keep the work area clean, uncluttered and ensure there is adequate lighting.
- Keep the riveter clean for best and safest performance.
- Check moving parts alignment on a regular basis.
- DO NOT** hold the workpiece by hand. Secure unstable workpiece with a clamp, vice or other adequate holding device.
- Ensure the workpiece is correctly secured before using the riveter.
- DO NOT** use the riveter for any purpose other than that it was designed for.
- DO NOT** operate the riveter if any parts are damaged or missing, as this may cause failure and/or personal injury.
- When not in use store in a safe, dry, childproof location.
- WARNING!** Always wear approved eye or face protection when operating the riveter.

2. INTRODUCTION

Comfortable ergonomic grips. Heavy-duty head suitable for fixing blind rivets and threaded nut rivets to thin sheet aluminium, steel and stainless steel. Short arms provide effortless functionality and access to restricted spaces. Supplied with nozzle spanner.

3. SPECIFICATION & CONTENTS

Model No.: AK3989
 Rivet Nut Sizes:
 M3 x 0.5, M4 x 0.7, M5 x 0.8, M6 x 1, M8 x 1.25, M10 x 1.5mm
 Blind Rivet Sizes:
 2.4mm (3/32"), 3.2mm (1/8"), 4mm (5/32"), 4.8mm (3/16"), 6.4mm (1/4")
 Length: 255mm
 Rivet Materials:
 Aluminium, Steel, Stainless Steel, Structural

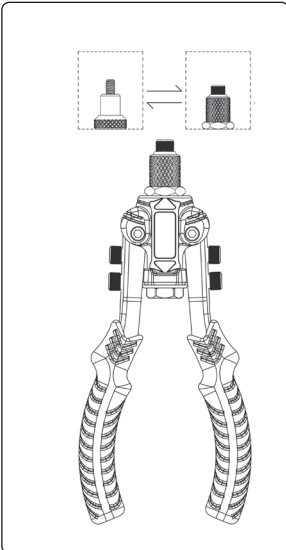
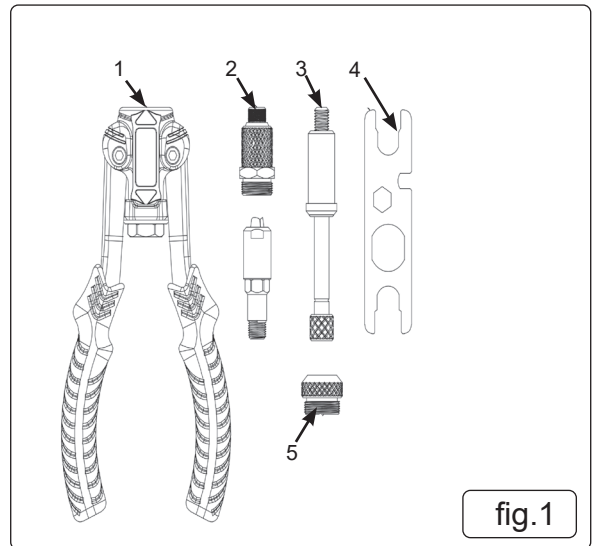

Item No.	Description
1	Hand Riveter Body
2	Hand Rivet Assembly (Rod + Sleeve + Nosepiece)
3	Nut Rivet Assembly (Rod + Sleeve)
4	Multi Function Spanner
5	Sleeve fixing Nut

4. OPERATION

4.1. RIVETING

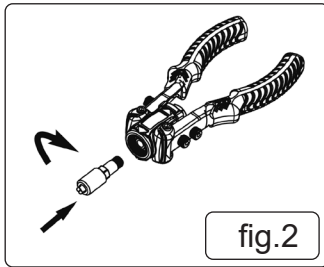

fig.2

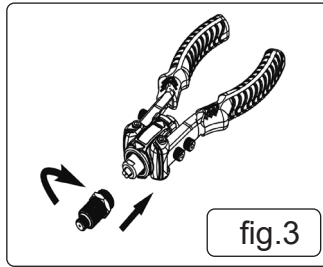

fig.3

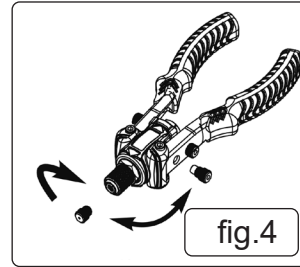

fig.4

- 4.1.1. Screw rivet assembly rod (fig.1.2) into the handle.(fig.2).
- 4.1.2. Screw rivet sleeve piece (fig.1.2) into the rod (fig.3).
- 4.1.3. Place correct size nose piece into unit (fig.4).
- 4.1.4. Drill a hole suitable for the specifications of the rivet on the two pieces of material to be riveted.
- 4.1.5. Insert a rivet gun fitted with rivets of appropriate specifications into the drilled hole.
- 4.1.6. Close the handle to fix the rivet in place, then withdraw the tool.

4.2. NUT RIVETING

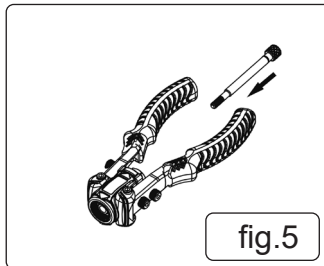

fig.5

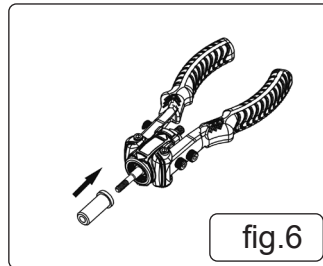

fig.6

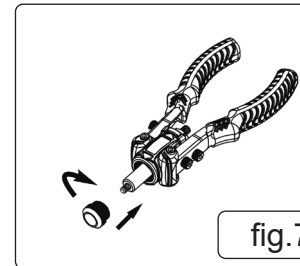

fig.7

- 4.2.1. Fit nut rivet rod (fig.1.3) into the handle (fig.5).
- 4.2.2. Insert the nut rivet sleeve (fig.1.3) into the body (fig.6).
- 4.2.3. Screw the sleeve fixing nut (fig.1.5) into the unit (fig.7).
- 4.2.4. Screw in the appropriate nut rivet.
- 4.2.5. Put nut rivet into the prepared hole and rive the nut rivet into place.
- 4.2.6. After riveting completed withdraw the tool.



ENVIRONMENT PROTECTION

Recycle unwanted materials instead of disposing of them as waste. All tools, accessories and packaging should be sorted, taken to a recycling centre and disposed of in a manner which is compatible with the environment. When the product becomes completely unserviceable and requires disposal, drain any fluids (if applicable) into approved containers and dispose of the product and fluids according to local regulations.

Note: It is our policy to continually improve products and as such we reserve the right to alter data, specifications and component parts without prior notice.

Important: No Liability is accepted for incorrect use of this product.

Warranty: Life-long guarantee from purchase date, proof of which is required for any claim.

Sealey Group, Kempson Way, Suffolk Business Park, Bury St Edmunds, Suffolk. IP32 7AR



01284 757500



01284 703534



sales@sealey.co.uk



www.sealey.co.uk