



ELECTRIC MIXER 80LTR 1220W/230V & 120LTR 1400W/230V

MODEL NO: **PM80L, PM120L**

Thank you for purchasing a Sealey product. Manufactured to a high standard, this product will, if used according to these instructions, and properly maintained, give you years of trouble free performance.

IMPORTANT: PLEASE READ THESE INSTRUCTIONS CAREFULLY. NOTE THE SAFE OPERATIONAL REQUIREMENTS, WARNINGS & CAUTIONS. USE THE PRODUCT CORRECTLY AND WITH CARE FOR THE PURPOSE FOR WHICH IT IS INTENDED. FAILURE TO DO SO MAY CAUSE DAMAGE AND/OR PERSONAL INJURY AND WILL INVALIDATE THE WARRANTY. KEEP THESE INSTRUCTIONS SAFE FOR FUTURE USE.



Refer to instructions



Wear eye protection



Wear protective gloves



Wear safety footwear



Wear ear protection

1. SAFETY

1.1. ELECTRICAL SAFETY

- ❑ **WARNING!** It is the user's responsibility to check the following:

Check all electrical equipment and appliances to ensure that they are safe before using. Inspect power supply leads, plugs and all electrical connections for wear and damage. Sealey recommend that an RCD (Residual Current Device) is used with all electrical products. You may obtain an RCD by contacting your local Sealey stockist.

If the product is used in the course of business duties, it must be maintained in a safe condition and routinely PAT (Portable Appliance Test) tested.

Electrical safety information, it is important that the following information is read and understood.

- 1.1.1. Ensure that the insulation on all cables and on the appliance is safe before connecting it to the power supply.
- 1.1.2. Regularly inspect power supply cables and plugs for wear or damage and check all connections to ensure that they are secure.
- 1.1.3. **Important:** Ensure that the voltage rating on the appliance suits the power supply to be used and that the plug is fitted with the correct fuse - see fuse rating in these instructions.

- * **DO NOT** pull or carry the appliance by the power cable.
- * **DO NOT** pull the plug from the socket by the cable. Remove the plug from the socket by maintaining a firm grip on the plug.
- * **DO NOT** use worn or damaged cables, plugs or connectors. Ensure that any faulty item is repaired or replaced immediately by a qualified electrician.

- 1.1.4. This product is fitted with a BS1363/A 13 Amp 3 pin plug.

If the cable or plug is damaged during use, switch the electricity supply and remove from use.

Replace a damaged plug with a BS1363/A 13 Amp 3 pin plug. If in doubt contact a qualified electrician.

Class II products are wired with live (brown) and neutral (blue) only are marked with the Class II symbol;

A) Connect the BROWN live wire to the live terminal 'L'.

B) Connect the BLUE neutral wire to the neutral terminal 'N'.

C) After wiring, check that there are no bare wires and ensure that all wires have been correctly connected.

Ensure that the cable outer sheath extends inside the cable restraint and that the restraint is tight.

- * **DO NOT** connect either wire to the earth terminal.

It is recommended that repairs are carried out by a qualified electrician.

1.2. GENERAL SAFETY

- ✓ Disconnect the mixer from the mains power before changing accessories, servicing or performing any maintenance.
- ✓ Maintain mixer in good condition. Check moving parts and alignment of mixing paddle. If necessary use an authorised service agent.
- ✓ Replace or repair damaged parts. Use recommended parts only. Unauthorised parts may be dangerous and will invalidate the warranty.
- ✓ Wear approved safety eye protection and a dust mask if mixing generates dust. Rubber gloves are recommended.
- ✓ Remove ill fitting clothing. Remove ties, watches, rings, other loose jewellery and contain long hair.
- ✓ Use mixer in an adequate working area for its function, keep area clean, tidy and free from unrelated materials and ensure adequate lighting.
- * **DO NOT** over-reach and ensure the floor is not slippery and wear non slip shoes. Maintain correct balance and footing.
- ✓ Always use both handle grips during use.
- ✓ Keep children and unauthorised persons away from the working area.
- ✓ Avoid unintentional starting of the mixer.
- * **DO NOT** use the mixer for a task which it was not designed to perform.
- * **DO NOT** operate mixer where there are flammable liquids or gasses.
- * **DO NOT** get the mixer wet or use in damp or wet locations.
- * **DO NOT** operate the mixer if any parts are missing or the mixer is damaged as this may cause failure and/or possible injury.
- * **DO NOT** operate the mixer when you are tired, under the influence of alcohol, drugs or intoxicating medication.
- * **DO NOT** carry the mixer with your finger on the power switch, or carry by the power cord, or leave the mixer running whilst unattended.
- ✓ When not in use switch mixer off, remove plug from power supply, clean the mixer and store in safe, dry, child proof area.

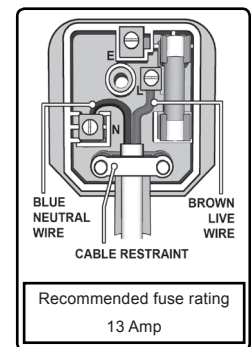

2. INTRODUCTION

Powerful electric mixer built into heavy-duty composite casing with a mixing volume of up to 80ltr (120ltr PM120L). Two speed settings and soft start allow for greater control when mixing a variety of materials. Supplied with two mixing paddles capable of mixing paint, varnish, tile adhesive, cement, plaster, mortar as well as a number of other liquid and dense materials. Lightweight design and over 2mtr of cable make this mixer easy to use.

3. SPECIFICATION

Model No.....	PM80L.....	PM120L
Motor power.....	1220W.....	1400W
Supply.....	230V.....	230V
No Load Speed.....	0-500rpm.....	0-800rpm
Mixing Capacity.....	80ltr.....	120ltr
Paddle Size.....	Ø120mm.....	Ø140mm.
Thread.....	M14.....	M14
Weight.....	4.7kg.....	7.5kg

4. OPERATION

- 4.1. Ensure that the tool is switched off and the power supply removed.
- 4.2. Screw mixing paddle E1 on to shaft E2, tighten with spanners G.
- 4.3. Screw mixing paddle assembly into mixer D.
- 4.4. Connect plug to power supply and switch on.
- 4.5. Ensure the mixing container is securely positioned on the floor.
- 4.6. Dip the mixing paddle into the substance to be mixed.
- 4.7. Set wheel C (Speed control) to low speed. Always hold the mixer with two hands.
- 4.8. Switch on the tool.
- 4.9. Gradually increase the mixing speed by turning wheel C to the desired maximum speed (so that the substance will not splash around and the tool will not be overloaded).
- 4.10. When mixing is complete switch off mixer before removing from substance.
- 4.11. Remove power supply and clean off paddle.

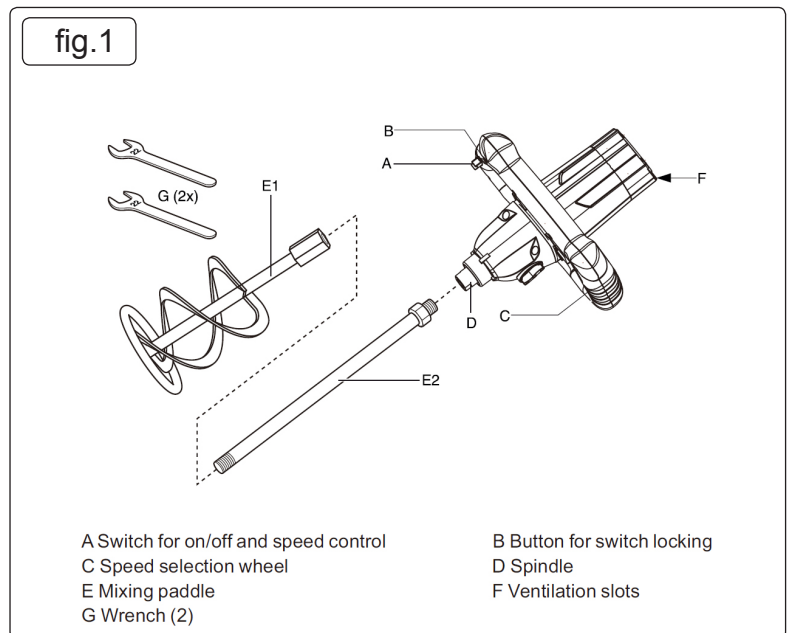

5. MAINTENANCE

- 5.1. Disconnect the plug before cleaning
 - 5.2. Always keep tool and cord clean (especially the ventilation slots).
 - 5.3. Always clean the mixer and functional parts after your mixing work.
 - 5.4. Clean the tool with a dry, soft cloth (do not use cleaning agents or solvents).
 - 5.5. Clean ventilation slots F regularly with a brush or compressed air.
- N.B.** When not in use switch mixer off, remove plug from power supply, clean the mixer and store in safe, dry, child proof area.



ENVIRONMENT PROTECTION

Recycle unwanted materials instead of disposing of them as waste. All tools, accessories and packaging should be sorted, taken to a recycling centre and disposed of in a manner which is compatible with the environment. When the product becomes completely unserviceable and requires disposal, drain any fluids (if applicable) into approved containers and dispose of the product and fluids according to local regulations.



WEEE REGULATIONS

Dispose of this product at the end of its working life in compliance with the EU Directive on Waste Electrical and Electronic Equipment (WEEE). When the product is no longer required, it must be disposed of in an environmentally protective way. Contact your local solid waste authority for recycling information.

Note: It is our policy to continually improve products and as such we reserve the right to alter data, specifications and component parts without prior notice.

Important: No Liability is accepted for incorrect use of this product.

Warranty: Guarantee is 12 months from purchase date, proof of which is required for any claim.

Sealey Group, Kempson Way, Suffolk Business Park, Bury St Edmunds, Suffolk. IP32 7AR



01284 757500



01284 703534



sales@sealey.co.uk



www.sealey.co.uk