

# DRAPER<sup>®</sup>

®

## INSTRUCTIONS FOR 13HP Petrol Pressure Washer

Stock No.83819 Part No.PPW1300

**IMPORTANT:** PLEASE READ THESE INSTRUCTIONS CAREFULLY TO ENSURE THE SAFE AND EFFECTIVE USE OF THIS PRODUCT.



CE

DRAPER<sup>®</sup>

### GENERAL INFORMATION

These instructions accompanying the product are the original instructions. This document is part of the product, keep it for the life of the product passing it on to any subsequent holder of the product. Read all these instructions before assembling, operating or maintaining this product.

This manual has been compiled by Draper Tools describing the purpose for which the product has been designed, and contains all the necessary information to ensure its correct and safe use. By following all the general safety instructions contained in this manual, it will ensure both product and operator safety, together with longer life of the product itself.

All photographs and drawings in this manual are supplied by Draper Tools to help illustrate the operation of the product.

Whilst every effort has been made to ensure the accuracy of information contained in this manual, the Draper Tools policy of continuous improvement determines the right to make modifications without prior warning.

# 1. TITLE PAGE

---

## **1.1 INTRODUCTION:**

USER MANUAL FOR:

## **13HP PETROL PRESSURE WASHER**

Stock no. 83819.

Part no. PPW1300.

## **1.2 REVISIONS:**

Date first published December 2015

---

---

---

As our user manuals are continually updated, users should make sure that they use the very latest version.

Downloads are available from: <http://www.drapertools.com/b2c/manuals>

DRAPER TOOLS LIMITED

HURSLEY ROAD

CHANDLER'S FORD

EASTLEIGH

HAMPSHIRE

SO53 1YF

UK

WEBSITE: [www.drapertools.com](http://www.drapertools.com)

PRODUCT HELPLINE: +44 (0) 23 8049 4344

GENERAL FAX: +44 (0) 23 8026 0784

## **1.3 UNDERSTANDING THIS MANUALS SAFETY CONTENT:**

**WARNING!** Information that draws attention to the risk of injury or death.

**CAUTION!** Information that draws attention to the risk of damage to the product or surroundings.

## **1.4 COPYRIGHT © NOTICE:**

Copyright © Draper Tools Limited.

Permission is granted to reproduce this publication for personal & educational use only.

Commercial copying, redistribution, hiring or lending is prohibited.

No part of this publication may be stored in a retrieval system or transmitted in any other form or means without written permission from Draper Tools Limited.

In all cases this copyright notice must remain intact.

---

# 2. CONTENTS

---

## 2.1 CONTENTS

<b>PAGE</b>	<b>CONTENT</b>	<b>PAGE</b>
1	TITLE PAGE	
	1.1 INTRODUCTION .....	2
	1.2 REVISION HISTORY.....	2
	1.3 UNDERSTANDING THIS MANUAL .....	2
	1.4 COPYRIGHT NOTICE.....	2
2	CONTENTS .....	3
3	GUARANTEE	
	3.1 GUARANTEE .....	4
4	INTRODUCTION	
	4.1 SCOPE .....	5
	4.2 SPECIFICATION.....	5
	4.3 HANDLING & STORAGE .....	5
5	HEALTH & SAFETY INFORMATION	
	5.1 GENERAL SAFETY INSTRUCTIONS FOR POWER TOOL USE .....	6-7
	5.2 SPECIFIC SAFETY INSTRUCTIONS FOR PRESSURE WASHER USE .....	8-9
6	TECHNICAL DESCRIPTION	
	6.1 IDENTIFICATION .....	10
7	UNPACKING & CHECKING	
	7.1 PACKAGING.....	11
	7.2 WHAT'S IN THE BOX? .....	11
8	ASSEMBLING THE PRESSURE WASHER	
	8.1 FRAME AND CABLE TIDY.....	12
	8.2 PRESSURE HOSE TO PRESSURE PUMP.....	12
	8.3 PRESSURE HOSE TO GUN .....	12
	8.4 LANCE TO GUN .....	13
	8.5 SELECTING THE RIGHT NOZZLE .....	13
	8.6 NOZZLES TO LANCE .....	14
	8.7 PRESSURE PUMP TO WATER SUPPLY .....	14
9	PREPARING THE PRESSURE WASHER	
	9.1 PRESSURE PUMP.....	15
	9.2 ADDING ENGINE OIL.....	15
	9.3 LOW OIL SENSOR .....	15
	9.4 ADDING PETROL .....	16
	9.5 USING PRESSURE WASHER AT HIGH ALTITUDES .....	16
10	OPERATING THE PRESSURE WASHER	
	10.1 STARTING .....	17
	10.2 USING THE GUN .....	18
	10.3 WASHING AND CLEANING .....	18
	10.4 PRESSURE ADJUSTMENT.....	19
	10.5 EXHAUST CONTROL SYSTEM .....	19
	10.5 PRESSURE ADJUSTMENT.....	19
	10.6 USING CHEMICALS AND CLEANING SOLVENTS.....	20
	10.7 SHUTTING DOWN .....	21
11	MAINTENANCE	
	11.1 MAINTENANCE SCHEDULE .....	22
	11.2 CHECKING PRESSURE PUMP OIL .....	23
	11.3 CHANGING PRESSURE PUMP OIL .....	23
	11.4 CLEANING NOZZLE.....	23
	11.5 CLEANING WATER INLET SCREEN FILTER .....	23
	11.6 CLEANING PRESSURE WASHER .....	24
	11.7 STORAGE .....	24
	11.8 PREPARING FOR USE AFTER STORAGE .....	26
12	TROUBLESHOOTING	
	12.1 TROUBLESHOOTING GUIDE.....	27
13	DISPOSAL	
	13.1 DISPOSAL.....	31
	DECLARATION OF CONFORMITY .....	ENCLOSED

## 3. GUARANTEE

---

### 3.1 GUARANTEE

Draper tools have been carefully tested and inspected before shipment and are guaranteed to be free from defective materials and workmanship.

Should the tool develop a fault, please return the complete tool to your nearest distributor or contact Draper Tools Limited, Chandler's Ford, Eastleigh, Hampshire, SO53 1YF. England. Telephone Sales Desk: (023) 8049 4333 or Product Helpline (023) 8049 4344.

A proof of purchase must be provided with the tool.

If upon inspection it is found that the fault occurring is due to defective materials or workmanship, repairs will be carried out free of charge. This guarantee period covering parts/labour is 12 months from the date of purchase except where tools are hired out when the guarantee period is 90 days from the date of purchase. The guarantee is extended to 24 months for parts only. This guarantee does not apply to normal wear and tear, nor does it cover any damage caused by misuse, careless or unsafe handling, alterations, accidents, or repairs attempted or made by any personnel other than the authorised Draper warranty repair agent.

Note: If the tool is found not to be within the terms of warranty, repairs and carriage charges will be quoted and made accordingly.

This guarantee applies in lieu of any other guarantee expressed or implied and variations of its terms are not authorised.

Your Draper guarantee is not effective unless you can produce upon request a dated receipt or invoice to verify your proof of purchase within the guarantee period.

Please note that this guarantee is an additional benefit and does not affect your statutory rights.

Draper Tools Limited.

## 4. INTRODUCTION

---

### 4.1 SCOPE

This manual is intended to give an overview of this machines features, functionality and safe operation.

### 4.2 SPECIFICATION

Stock no. ....	83819
Part no. ....	PPW1300
Engine .....	13HP 4-stroke
Engine displacement .....	389cc
Speed (no load) .....	3350-3550 r/min
Working pump pressure .....	234bar (3400psi)
Max. pump pressure .....	262bar (3800psi)
Delivery .....	720l/h (12l/m)
Weight (nett).....	55kg

### 4.3 HANDLING & STORAGE

This machine should be stored in a dry location and in its box. Avoid storing this machine in areas prone to damp or humidity.

Remove residual fuel from the fuel tank if storing for several months.

Run clean water through chemical inlet.

Do not allow water to freeze in pump, gun, lance or hose.

## 5. HEALTH & SAFETY INFORMATION

---

### 5.1 GENERAL SAFETY INSTRUCTIONS FOR POWER TOOL USE

When using any type of power tool there are steps that should be taken to make sure that you, as the user, remain safe.

Common sense and a respect for the tool will help reduce the risk of injury.

**Read the instruction manual fully.** Do not attempt any operation until you have read and understood this manual.

Most important you must know how to safely start and stop this machine, especially in an emergency.

**Keep the work area tidy and clean.** Attempting to clear clutter from around the machine during use will reduce your concentration. Mess on the floor creates a trip hazard. Any liquid spilt on the floor could result in you slipping.

**Find a suitable location.** If the machine is bench mounted; the location should provide good natural light or artificial lighting as a replacement. Avoid damp and dust locations as it will have a negative effect on the machine's performance.

If the machine is portable; do not expose the tool to rain. In all cases do not operate power tools near any flammable materials.

**Beware of electric shock.** Avoid contact with earthed surfaces; because they can conduct electricity if there is an electrical fault with the power tool. Always protect the power cable and route it away from danger.

**Keep bystanders away.** Children, onlookers and passers by must be restricted from entering the work area for their own protection. The barrier must extend a suitable distance from the tool user.

**Unplug and house all power tools that are not in use.** A power tool should never be left unattended while connected to the power supply. They must be housed in a suitable location, away locked up and from children.

**Do not overload or misuse the tool.** All tools are designed for a purpose and are limited to what they are capable of doing. Do not attempt to use a power tool (or adapt it in any way) for an application it is not designed for. Select a tool appropriate for the size of the job. Overloading a tool will result in tool failure and user injury: This covers the use of accessories.

**Dress properly.** Loose clothing, long hair and jewellery are all dangerous because they can become entangled in moving machinery: This can also result in parts of body being pulled into the machine.

Clothing should be close fitted, with any long hair tied back and jewellery and neck ties removed. Footwear must be fully enclosed and have a nonslip sole.

## 5. HEALTH & SAFETY INFORMATION

---

**Wear personal protective equipment (PPE).** Dust, noise, vibration and swarf can all be dangerous if not suitably protected against. If the work involving the power tool creates dust or fumes; wear a dust mask. Vibration to the hand, caused by operating some tools for longer periods must be protected against. Wear vibration reducing gloves and allow long breaks between uses. Protect against dust and swarf by wearing approved safety goggles or a face shield. These are some of the more common hazards and preventions; however, always find out what hazards are associated with the machine/work process and wear the most suitable protective equipment available.

**Do not breathe contaminated air.** If the work creates dust or fumes; connect the machine (if possible) to an extraction system either locally or remotely. Working outdoors can also help if possible.

**Move the machine as instructed.** If the machine is hand held, do not carry it by the power supply cable. If the product is heavy; employ a second or third person to help move it safely or use a mechanical device. Always refer to the instructions for the correct method.

**Do not overreach.** Extending your body too far can result in a loss of balance and you falling. This could be from a height or onto a machine and will result in injury.

**Maintain your tools correctly.** A well maintained tool will do the job safely. Replace any damaged or missing parts immediately with original parts from the manufacturer. As applicable; keep blades sharp; moving parts clean, oiled or greased; handles clean; and emergency devices working.

**Wait for the machine to stop.** Unless the machine is fitted with a safety brake; some parts may continue to move due to momentum. Wait for all parts to stop; then unplug it from the power supply before making any adjustments, carrying out maintenance operations or just finishing using the tool.

**Remove and check setting tools.** Some machinery requires the use of additional tools or keys to set, load or adjust the power tool. Before starting the power tool always check to make certain they have been removed and are safely away from the machine.

**Prevent unintentional starting.** Before plugging any machine in to the power supply, make sure the switch is in the OFF position. If the machine is portable; do not hold the machine near the switch and take care when putting the machine down; that nothing can operate the switch.

**Carefully select an extension lead.** Some machines are not suitable for use with extension leads. If the tool is designed for use outdoors; use an extension lead also suitable for that environment. When using an extended lead, select one capable of handling the current (amps) drawn by the machine in use. Fully extend the lead regardless of the distance between the power supply and the tool. Excess current (amps) and a coiled extension lead will both cause the cable to heat up and can result in fire.









**Concentrate and stay alert.** Distractions are likely to cause an accident. Never operate a power tool if you are under the influence of drugs (prescription or otherwise), including alcohol or if you are feeling tired. Being disorientated will result in an accident.



**Have this tool repaired by a qualified person.** This tool is designed to conform to the relevant international and local standards and as such should be maintained and repaired by someone qualified; using only original parts supplied by the manufacturer: This will ensure the tool remains safe to use.

## 5. HEALTH & SAFETY INFORMATION

---

### 5.2 SPECIFIC SAFETY INSTRUCTIONS FOR PRESSURE WASHER USE







-  Warning: This appliance is for outdoor use only.
-  Warning: Always disconnect the electricity and water supplies on completion of every job.
-  Warning: Never use the appliance if the electrical cable or important parts of the appliance are damaged, e.g. safety devices, high pressure hose, gun, etc.
-  Warning: This appliance has been designed for use with a neutral shampoo based on biodegradable anionic surface active detergents. The use of other detergents or chemicals may put the appliance's safety at risk.
-  Warning: Never use the appliance with people in the vicinity, unless they are wearing protective clothing.
-  Warning: Do not direct the nozzle toward mechanical parts containing lubricant grease, as the grease will dissolve and spread over the surrounding ground. Vehicle tyres/tyre valves may only be cleaned from a minimum distance of 30cm, otherwise the vehicle tyre/tyre valve could be damaged by the high-pressure jet. The first indication of this is a discolouration of the tyre. Damaged vehicle tyres/tyre valves can be deadly dangerous.
-  Warning: High pressure jets may be dangerous if improperly used. Jets must never be pointed at people, animals, live electrical equipment or the appliance itself.
-  Warning: The hoses, accessories and high pressure couplings are important for the appliance's safety. Use only hoses, accessories and couplings recommended (it is extremely important to protect these components against damage by avoiding their improper use and protecting them against bending, knocks and scratches).

The gun is fitted with a safety catch. Whenever use of the machine is interrupted it is important to operate the safety catch to prevent accidental activation of the jet.
-  Warning:
  - Never point the jet at yourself or others to clean clothing or footwear.
  - Never allow children or untrained people to use the appliance.
  - Safety features: gun equipped with safety locking device, appliance equipped with (Class 1) overload cutout, pump equipped with by-pass valve or shutdown device.
  - The safety button on the gun is not there to lock the lever during operation, but to prevent its accidental operation.
-  Warning: Appliances equipped with Total Stop System: these appliances should not be left in standby for more than 5 minutes.
-  Warning: Switch the appliance off completely (master switch ON/OFF) whenever it is left unattended.



## 5. HEALTH & SAFETY INFORMATION

---

-  Warning: Every machine is tested in its operating conditions, so it is normal for a few drops of water to be left inside it.
-  Warning: Take care not to damage the electric cable. Have a damaged power cord replaced immediately by an authorized service point or an electrical specialist.
-  Warning: The high pressure hose is designed and produced to withstand high pressures. To avoid damage, it must be handled with special care. Misuse may lead to premature breakages or damage and cause the loss of warranty cover.
-  Warning: Never start the high-pressure cleaner without first completely unwinding the high-pressure hose.
-  Warning: When winding and unwinding the hose take care not to cause the high pressure cleaner to overturn.
-  Warning: Before unwinding or winding the hose, switch the machine off and release the pressure in the hose itself (switching off).

## 6. TECHNICAL DESCRIPTION

---

### 6.1 IDENTIFICATION

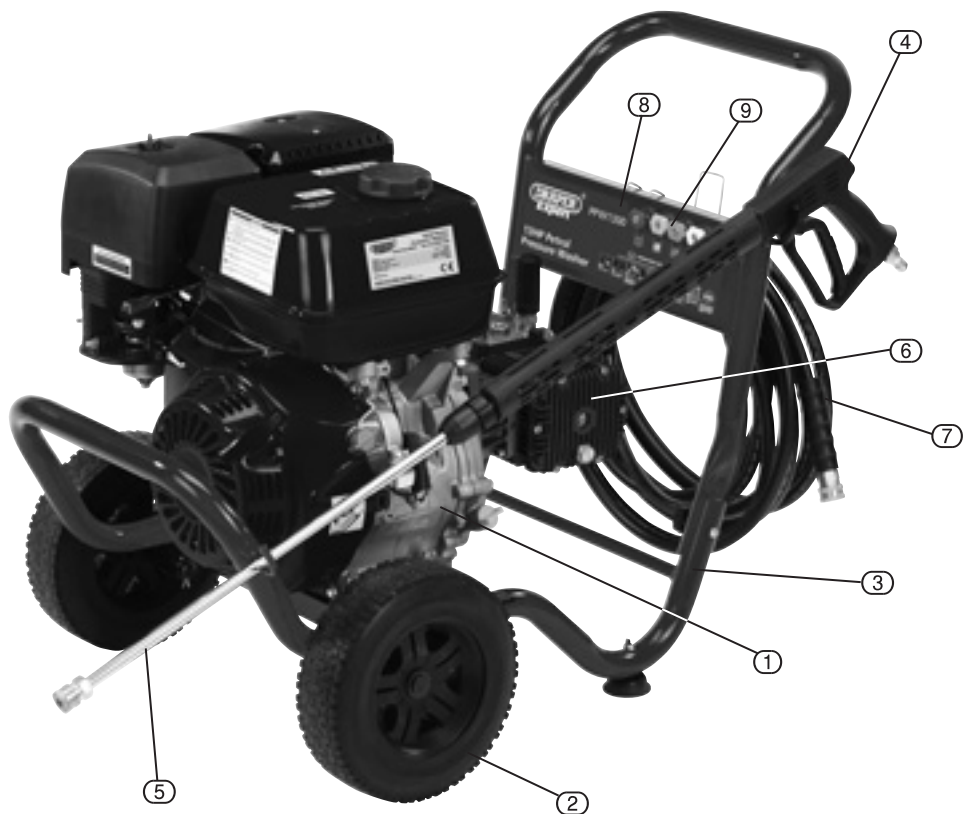

① Petrol engine.

② Wheel.

③ Frame.

④ Gun.

⑤ Lance.

⑥ Pressure pump.

⑦ High pressure hose.

⑧ Nozzle panel.

⑨ Selection of nozzles.

## 7. UNPACKING & CHECKING

### 7.1 PACKAGING

Carefully remove the machine from the packaging and examine it for any sign of damage that may have happened during shipping. Lay the contents out and check them against the parts shown below. If any part is damaged or missing; please contact the Draper Helpline (the telephone number appears on the Title page) and do not attempt to use the machine.

The packaging material should be retained at least during the guarantee period: in case the machine needs to be returned for repair.

**Warning!** Some of the packaging materials used may be harmful to children. Do not leave any of these materials in the reach of children.

If any of the packaging is to be thrown away, make sure they are disposed of correctly; according to local regulations.

### 7.2 WHAT'S IN THE BOX?

As well as the main machine; there are several parts not fitted or attached to it.

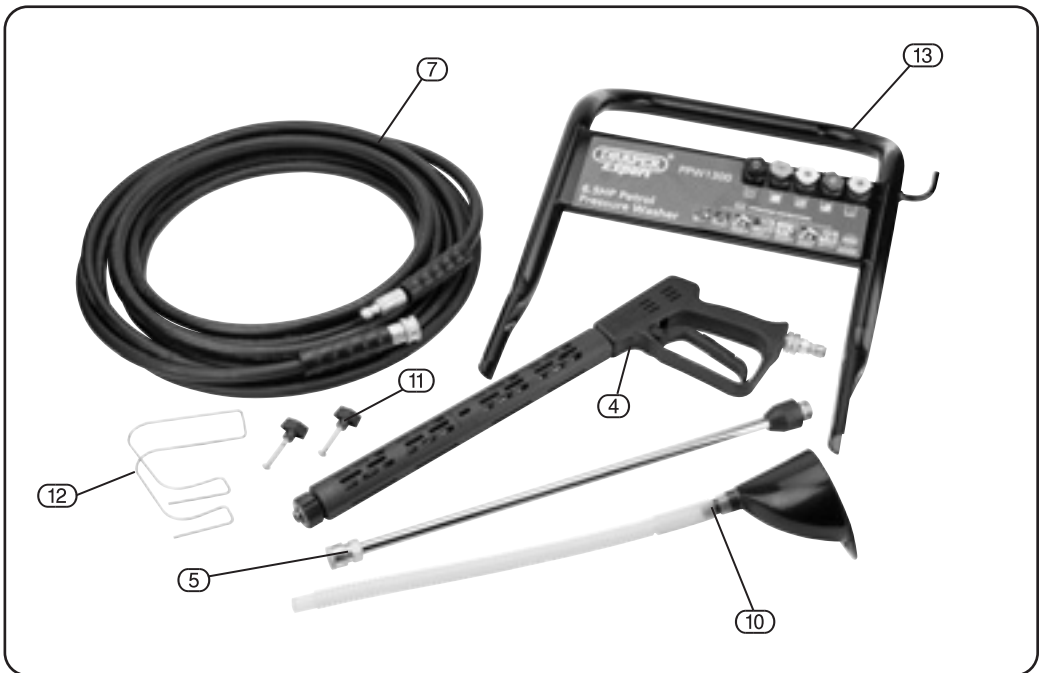

- |                       |                        |
|-----------------------|------------------------|
| ④ Gun.                | ⑪ Frame locking knobs. |
| ⑤ Lance.              | ⑫ Cable tidy.          |
| ⑦ High pressure hose. | ⑬ Handle.              |
| ⑩ Oil funnel.         |                        |

## 8. ASSEMBLING THE PRESSURE WASHER

**WARNING: Unit is heavy.** Do not attempt to lift and remove the pressure washer from the box unaided.

The pressure washer comes almost fully assembled.

### 8.1 FRAME AND CABLE TIDY - FIGS.1 & 2

The frame handle (13) is assembled to the frame (3) by securing with the frame locking knobs (11).

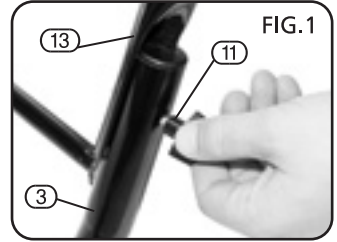

Attach the cable tidy by slotting into the holes on top of the nozzle panel.



### 8.2 PRESSURE HOSE TO PRESSURE PUMP - FIG.3

Pull back the high pressure outlet fitting collar, Insert Pressure Hose inside the fitting and release collar. Tug on the hose to make sure it is secured.

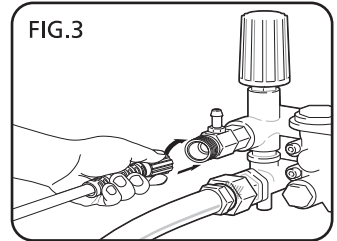

### 8.3 PRESSURE HOSE TO GUN - FIG.4

1. Pull slip ring on female quick-disconnect fitting of high pressure hose back.
2. Insert male quick-disconnect fitting on spray gun into female quick-disconnect on high pressure hose
3. Release slip ring on female quick-disconnect and twist. Listen for “click” to ensure both quick-disconnects are coupled.
4. Pull high pressure hose and spray gun in opposite direction to ensure they do not separate.

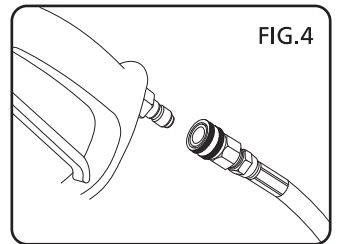

## 8. ASSEMBLING THE PRESSURE WASHER

### 8.4 LANCE TO GUN- FIG.5

1. Remove the protective plastic cap at the inlet of the lance.
2. Thread lance onto gun.
3. Tighten the nut to secure the lance to the gun.

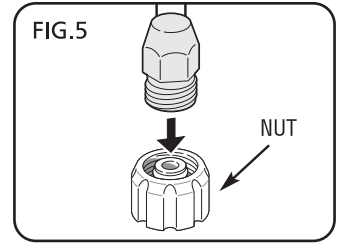

### 8.5 SELECTING THE RIGHT NOZZLE - FIGS.6-10

**NOTE:** To prevent damage to your surface and to select an appropriate nozzle size for your application, always start with the lowest pressure nozzle (white) and continue changing to the higher nozzle size until the best result is achieved.

The Pressure Washer comes furnished with five spray nozzles. Each nozzle is colour coded and delivers a specific spray pattern and pressure for a particular cleaning job. The size of the nozzle determines the size of the fan spray and the pressure out of the nozzle.

**0° Nozzle – Red:** This nozzle delivers a pinpoint stream of pressurised water and is extremely powerful. It covers only a small area of cleaning. This nozzle should only be directed at surfaces that can withstand high pressure such as metal or concrete. Do not use this nozzle to clean wood.

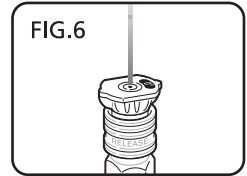

**15° Nozzle – Yellow:** This nozzle delivers a powerful 15 degree spray pattern for intense cleaning of small areas. This nozzle should only be used on areas and materials that can withstand high pressure.

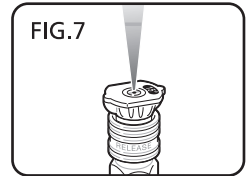

**25° Nozzle – Green:** This nozzle delivers a 25 degree spray pattern for intense cleaning of larger areas. This nozzle should only be used on areas that can withstand pressure from this nozzle.

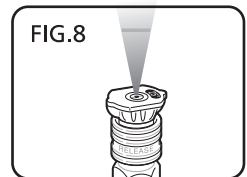

**40° Nozzle – White:** This nozzle delivers a 40 degree spray pattern and a less powerful stream of water. This nozzle can cover a wide area and should be used for most general cleaning jobs

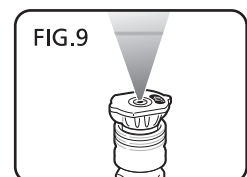

## 8. ASSEMBLING THE PRESSURE WASHER

**Chemical Nozzle – Black:** This nozzle is used to apply special chemicals and cleaning solutions. This nozzle produces the weakest pressure stream of the five nozzles.

The Pressure Washer nozzles are stored in receptacles on a panel mounted to the handle of the washer colours on the panel identify nozzle location and spray panel.

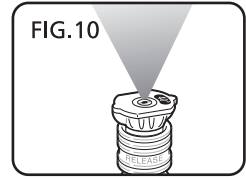

### 8.6 NOZZLES TO LANCE - FIG.11

**WARNING: Never place hands in front of nozzle. Never grasp hose or fittings during operation. Never attempt to attach or remove spray wand or hose fittings while pressure washer system is pressurised. Turn off pressure washer and lock the gun trigger before attempting to change pressure nozzles.**

1. To attach, insert nozzle into female quick-disconnect spray wand and press to snap in the nozzle.
2. To detach, slide down slip ring on female quick-disconnect to eject the nozzle

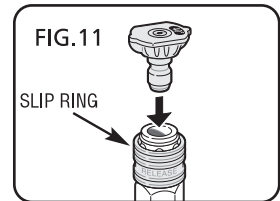

### 8.7 PRESSURE PUMP TO WATER SUPPLY - FIG.12

1. Connect the garden hose to the water supply and turn water supply on to fill the hose with water and also remove any debris in the hose. Turn OFF water supply.
2. Make sure that the filter inside Pressure Washer water inlet is clean and undamaged. Thread the garden hose fitting into water hose inlet. Hand tighten the inlet nut.
- 3 Turn on water supply

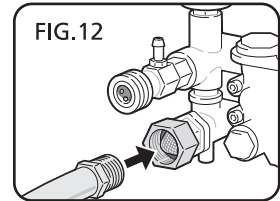

**NOTE:** The pressure washer requires a minimum of 20psi and a flow rate of 19L/m.

## 9. PREPARING THE PRESSURE WASHER

**WARNING: Improper treatment of the pressure washer can damage internal components and shorten the life of this unit. Failure to follow this warning will void warranty.**

### 9.1 PRESSURE PUMP - FIG.13

The Pressure Washer is shipped with shipping oil plug to prevent oil leakage from the pump during shipping. To replace the shipping plug with the Breather Plug (provided) perform the following:

**WARNING: Failure to remove shipping plug and replace it with the dipstick/oil plug will damage the pressure pump. Failure to add pump breather plug could void warranty.**

1. Using a spanner, remove shipping plug from pressure pump.  
Discard shipping plug.
2. Remove pump Breather Plug from parts bag and insert it into pressure pump.
3. Tighten pump Breather Plug securely by hand. Do not use spanner to tighten. Using a spanner to tighten pump Breather Plug could strip threads.
4. Use the oil level glass window on the side of the pump to ensure that pump oil is at mid point or above.
5. Add oil to pressure pump if level is below the prescribed level. We recommend GEAR SYNTHETIC OIL ISO 150.

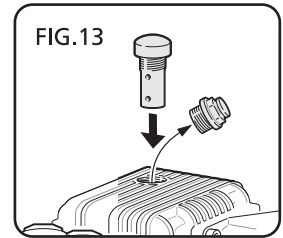

### 9.2 ADDING ENGINE OIL - FIG.14

1. Move the Pressure Washer **OUTSIDE** and place on a flat and level surface.
2. Remove the engine oil dip stick and place funnel in the oil reservoir.
3. Pour the engine oil (SAE 15W-40) (not supplied) until oil level reaches the threads inside the oil reservoir.
4. Hand tighten oil dip stick and wipe off any spilled oil.

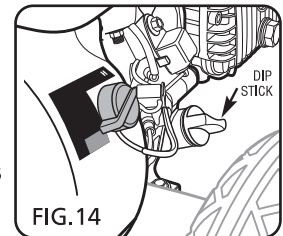

### 9.3 LOW OIL SENSOR

To prevent engine damage caused by an insufficient amount of oil in the crankcase, engine is equipped with low oil sensor. If the oil is below the safe amount, the sensor will activate and will prevent engine start-up or will stop the running engine.

If Pressure Washer shuts off and the oil level is within specifications, check to see if Pressure Washer is sitting at an angle that forces oil to shift.

Place on an even surface to correct this. If engine fails to start, the oil level may not be sufficient to deactivate low oil level sensor. Add oil as described above.

## 9. PREPARING THE PRESSURE WASHER

### 9.4 ADDING PETROL - FIG.15

1. Move the Pressure Washer **OUTSIDE** and place on a flat and level surface.
2. Remove the petrol tank cap. Carefully add Standard Unleaded petrol to the tank. **DO NOT OVERFILL**. Leave room for the petrol to expand.
3. Replace and hand tighten petrol tank cap and wipe off any spilled fuel.

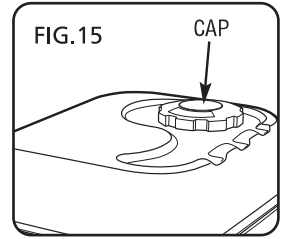

**WARNING: Petrol and petrol vapour are extremely flammable and explosive. Fire or explosion from misuse of fuel can cause severe burns and even death. Failure to use fuel as recommend in this manual will void the warranty.**

**WHEN ADDING FUEL TO PRESSURE WASHER, OBSERVE THE FOLLOWING:**

- **DO NOT** use unapproved petrol.
- **DO NOT** mix oil with petrol.
- **DO NOT** modify engine to run on alternate fuels.
- Turn Pressure Washer **OFF** and let it cool for at least two minutes before removing fuel cap. Loosen fuel cap slowly to release pressure.
- Keep fuel away from sparks, open flames, pilot lights, heat and other ignition sources.
- **DO NOT** light a cigarette or smoke near open fuel tank or container.
- Clean area around fuel fill cap and slowly remove cap to allow any pressure to escape.
- Install fuel cap and allow any spilled fuel to evaporate before starting engine.
- **DO NOT** overfill fuel tank. Slowly add unleaded petrol (**A**) to fuel tank (**B**). Use extreme caution not to fill fuel above baffle (**C**). This allow appropriate space for fuel expansion.

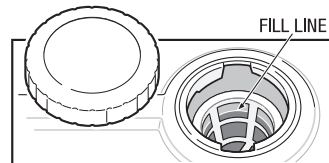
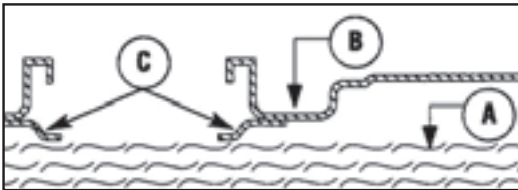

### 9.5 USING PRESSURE WASHER AT HIGH ALTITUDES

Engine Carburetor is factory adjusted for optimum operation from 0 to 1500 meters above the sea level. Approximately 10 % of power drop in the engine is expected with respect to each 1000 meters of altitude. To maintain proper emissions compliance and optimum performance & fuel consumption high altitude adjustment may be required for altitudes above 1500 metres.



# 10. OPERATING THE PRESSURE WASHER

## 10.1 STARTING

**PRIOR TO STARTING THE PRESSURE WASHER, MAKE SURE THAT YOU HAVE:**

1. Selected a proper size nozzle for the job at hand (see "SELECTING THE RIGHT NOZZLE").
2. Attached the Pressure Washer to the water source and turned on the source (see "PRESSURE PUMP TO WATER SUPPLY").

**WARNING: DO NOT** run the pump without the water supply connected and turned on. Damage to the pressure washer resulting from failure to follow this instruction **WILL** void the warranty.

3. For your protection, wear protective safety glasses (not provided).
4. Move the Pressure Washer **OUTSIDE** in a fully **VENTILATED** area.
5. Place the Pressure Washer on a **FLAT** and level surface and close to the working surface. Keep a minimum of **(1.5 metres) CLEARANCE** on all sides of the engine including top. Face the engine exhaust outlet **AWAY** from buildings.

6. Make sure the Throttle lever is set to the **"FAST"** position (left).

7. Slide the Fuel Valve lever to **"ON"** position (right) to allow the fuel to flow to the engine.

8. Slide the Choke Lever to **"START"** position (left).

9. Turn the Engine **ON/OFF** switch clockwise to **ON** position.

10. Point nozzle to a safe direction and squeeze the Spray Gun trigger to allow for easier engine start.

11. To start the engine, pull Starter cord slowly until resistance is felt, then pull rapidly to avoid kick back. Repeat until engine starts to run. Release the trigger.

12. Slide Choke Lever to **"RUN"** (right) position..

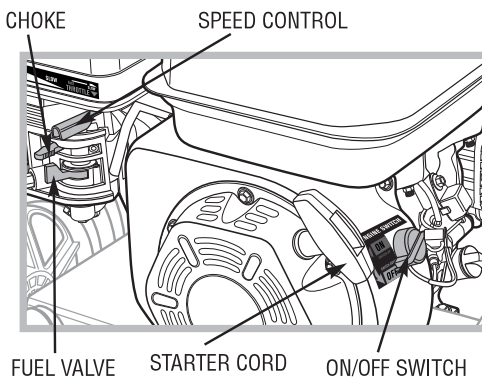

**WARNING: Do not leave pressure washer in bypass mode for more than two minutes at a time. Water temperature inside the pressure pump will rise to a dangerous level resulting in damage to the internal components of the pump. Failure to follow this warning will void warranty.**

**DO NOT** run the pressure pump without the water supply connected and turned on. Damage to the pressure washer resulting from failure to follow this instruction **WILL** void the warranty.

**ALWAYS wear approved safety glasses when operating pressure washers.** Spray can splash back or propel objects, including incorrectly attached accessories.

# 10. OPERATING THE PRESSURE WASHER

**WARNING:** The high pressure stream of water that this equipment produces can cut through skin and it's underlying tissues, leading to possible amputation. gun traps high water pressure, even when the motor is stopped and water is disconnected, which can cause injury. Kickback from gun can cause you to fall.

## 10.2 USING THE GUN - FIG.16

To engage the Trigger Lock, pull the lock up until it clicks into the slot.

To disengage the Trigger Lock, push the lock down and into its original position.

### TO OPERATE THE TRIGGER:

1. Squeeze the trigger to start water flow through the nozzle.
2. Release the trigger to stop water flow.

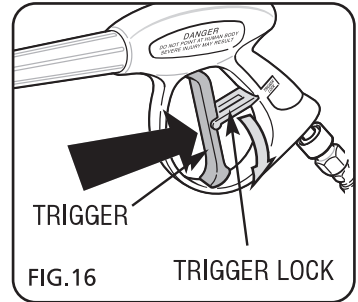

## 10.3 WASHING AND CLEANING

1. Firmly grip gun with both hands.
2. Point the nozzle to a safe direction and squeeze the gun trigger to allow the pump to purge air and impurities in the system and then redirect the the nozzle to the working surface.
3. When finished, release the Gun Trigger to stop water flow.

### USAGE TIPS:

- For most effective cleaning, keep spray nozzle from 20 to 60cms away from cleaning surface.
- If you get spray nozzle too close, especially using high pressure mode, you may damage surface being cleaned.
- **DO NOT** get closer than 20cms when cleaning tyres.

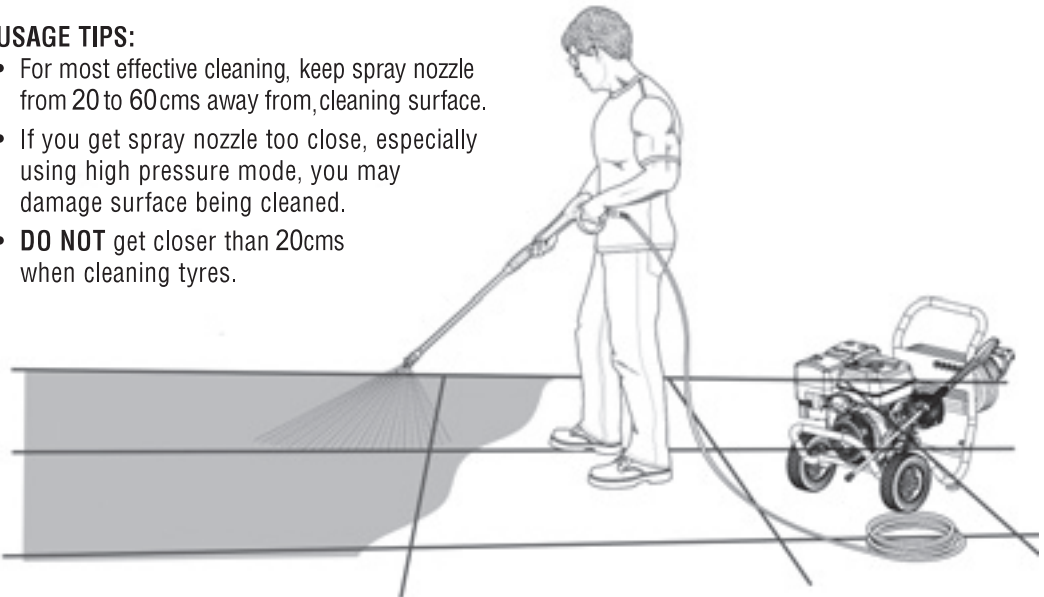

# 10. OPERATING THE PRESSURE WASHER

## 10.4 PRESSURE ADJUSTMENT

**Increase distance:** To vary the pressure on the surface being cleaned, vary the distance between spray wand and the surface being cleaned.

**Change pressure wand nozzle:** Completely shut down Pressure Washer and stop petrol engine. Change spray nozzle for desired pressure (see "SELECTING THE RIGHT NOZZLE"). Restart engine.

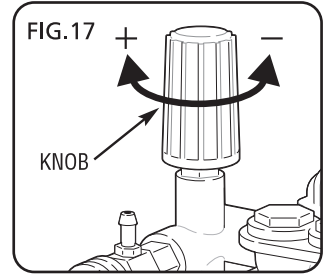

### ADJUST PUMP PRESSURE REGULATOR - FIG. 17

The pump pressure regulator allows pressure adjustment at the pump. Turn pressure regulator knob on pressure pump counterclockwise/clockwise to decrease/increase pressure.

## 10.5 EXHAUST CONTROL SYSTEM

With the engine running, carbon monoxide, nitrogen oxide and hydrocarbon are produced, and in certain conditions nitrogen oxide and hydrocarbon will react together to make smoke while carbon monoxide is toxic, so exhaust control is very important. The manufacturer decreases exhaust emissions by introducing poor-fuel carburetors and other devices to solve the problem. To keep the exhaust of your engine within the standard exhaust emission values, pay attention to the following:

### - MAINTENANCE

Maintain the engine periodically in accordance with the maintenance schedule.

The maintenance schedule is made out on the basis of normal use in normal conditions.

If using under heavy load, dusty or wet conditions or in high temperature, more frequent maintenance will be necessary.

### - REPLACEMENT OF PARTS

We recommend that you use parts that are supplied by the manufacturer or equivalent quality parts. Replacement parts of inferior quality may impair the effectiveness of the exhaust control system.

### - MODIFYING

Modifying the exhaust control system may make exhaust emissions exceed statutory limits. Illegal modifications could be:

Dismantling or modifying any part of the air inlet or outlet system.

Modifying or removing speed adjustment controls or connections which may result in the engine running outside its set parameters.

### - PROBLEMS AFFECTING EXHAUST EMISSIONS

Difficulty in starting or stopping.

Erratic idling.

Giving off black smoke or excessive fuel consumption.

Poor ignition spark or no spark.

Ignition too advanced.

If you have any of these above problems please contact your dealer.

# 10. OPERATING THE PRESSURE WASHER

---

## 10.6 USING CHEMICALS AND CLEANING SOLVENTS

**NOTE:** Use only soaps and chemicals designed for use with pressure washers.

**DO NOT USE CHLORINE BLEACH.**

Chemicals, soaps and cleaning solvents will not siphon when a high pressure nozzle is used. Use the chemical nozzle (black).

### TO APPLY DETERGENT:

1. Prepare detergent solution as recommended and suitable for application (see Draper catalogue).
2. Remove the detergent tank lid located in front of the Pressure Washer.
3. Fill tank with prepared detergent solution. A small funnel may help with this task. Replace the detergent tank lid.
4. Lock the trigger and attach the Detergent Nozzle (Black) to the lance.
5. Unlock the trigger and squeeze spray gun trigger and apply detergent to a dry surface, starting at lower portion of area to be washed and work upward, using long, even, overlapping strokes.

**NOTE:** Wetting the surface first is not recommended, as it dilutes the detergent and reduces its cleaning ability.

6. Allow detergent to "soak in" for 3-5 minutes before washing and rinsing.  
Reapply as needed to prevent surface from drying. Do **Not** allow detergent to dry on surface (prevents streaking).

### TO RINSE:

1. Replace the nozzle with an appropriate high pressure nozzle (see "SELECTING THE RIGHT NOZZLE"). Squeeze the trigger and wait for the detergent to clear.
2. Keep the gun a safe distance from the area you plan to spray.
3. Apply a high pressure spray to a small area, and then check the surface for damage. If no damage is found, it is ok to continue cleaning.
4. Start at the top of the area to be rinsed, working down with same overlapping strokes as you used for washing and applying detergent.

### TO FLUSH SYSTEM

When you have completed the use of detergent injection system:

1. Turn off the engine and fill the detergent tank with clean water.
2. Remove the nozzle and then turn engine back on.
3. Point the lance toward a safe direction and squeeze the trigger to flush clean water through the detergent tank and the system until it is thoroughly clean.

# 10. OPERATING THE PRESSURE WASHER

---

**WARNING:** Leaving chemicals and cleaning solutions inside the pressure pump could damage it. Damages created by leaving soaps, chemicals and cleaning solutions inside the pump can void the warranty.

## **CLEANING TIPS:**

- Never use the Pressure Washer water inlet to siphon detergent or wax.
- If you have the nozzle too far away from the surface being washed, the cleaning will not be as effective.

**IMPORTANT: DO NOT** get closer than 20cms when cleaning.

## **10.7 SHUTTING DOWN**

1. To stop the engine, set the engine switch on the side of the engine to OFF position.
2. Slide Fuel Valve lever to the left to stop fuel flow to the engine.
3. Turn off the water supply and disconnect garden hose from the Pressure Washer.
4. Squeeze the Gun trigger to release any remaining water in the system.
5. Store Spray Gun on the side and hoses inside the hose housing inside the handle.
6. **CAUTION - Allow engine to cool down before folding handle.**

**IMPORTANT:** Never turn off water supply with engine running. This will cause the pressure pump to overheat resulting in internal damage.

Pressure washer **MUST** be properly stored. Refer to next pages for proper storage instructions.

# 11. MAINTENANCE

## 11.1 MAINTENANCE SCHEDULE

Regular maintenance will improve performance and extend life of Pressure Washer.

Pressure Washer's warranty does not cover items that have been subjected to operator abuse or negligence. Only by maintaining Pressure Washer in accordance with instructions in this manual will the full value of the warranty be honored.

Some adjustments will need to be made periodically to properly maintain the Pressure Washer. All service and adjustments should be made at least one time each season. It is important that the maintenance chart below be followed.

### ENGINE MAINTENANCE SCHEDULE

Frequency	Items	Each time	Every month or 20 Hrs	Every 3 months or 50 Hrs	Every 6 months or 100 Hrs	Every year or 300 Hrs
Engine oil	Check oil level	✓				
	Replace				✓	
Air cleaner (Filter)	Check	✓				
	Clean			✓	✓ *	
	Replace-clean					✓
Deposit cup	Clean				✓	
Spark plug	Clean, adjust				✓ * * *	
	Replace					✓
Spark Arrester	Clean				✓	
Idling	Check-adjust					✓ * *
Valve clearance	Check-adjust					✓ * *
Fuel tank	Clean					✓ * *
Fuel supply line	Check	Every two years (Replace if necessary**)				

\* Recommended to be performed more often than in the schedule if operated in dusty environments.

\*\* Recommended to be performed by authorized dealers

\* \* \* Adjust air gap to 0.6mm - 0.7mm

# 11. MAINTENANCE

## 11.2 CHECKING PRESSURE PUMP OIL

1. Check oil site gauge on pressure pump. Oil should cover site gauge.

## 11.3 CHANGING PRESSURE PUMP OIL - FIG.18

1. Place container under pressure pump oil drain plug.
2. Using a wrench, loosen oil drain plug.
3. Remove oil drain plug and drain oil into container.
4. Replace oil drain plug and retighten using the wrench.
5. Loosen and remove breather plug from top of pressure pump.
6. Add **NEW** GEAR SYNTHETIC OIL ISO 150 to pump case until the oil level raises above the midpoint on the oil level window on the side of the pump.
7. Replace and hand tighten the breather plug.

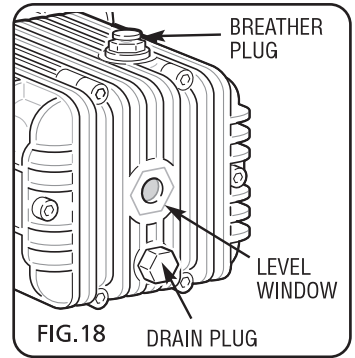

## 11.4 CLEANING NOZZLE - FIG.19

Occasionally, the lance can become clogged with foreign materials such as dirt. When this happens, excessive pressure can develop. Whenever the pressure nozzle becomes partially clogged, the pump pressure will pulsate. It should be immediately cleaned.

1. Make sure Pressure Washer is shut off and spray gun trigger is locked.
2. Remove high pressure spray nozzle from the lance. Using the nozzle cleaning needle (provided), remove any obstructions by inserting and carefully moving the pin back-and-forth through nozzle hole under clean running water.
3. After cleaning, remove the needle from nozzle and store for future use.
4. Reassemble pressure nozzle to spray wand.

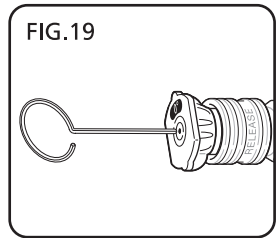

## 11.5 CLEANING WATER INLET SCREEN FILTER - FIG.20

The water inlet screen filter should be checked periodically and cleaned if necessary.

1. Disconnect inlet water hose.
2. Remove filter by grasping end and pull straight back.
3. Clean screen filter by flushing both sides with water.
4. Insert screen filter back inside water inlet port.

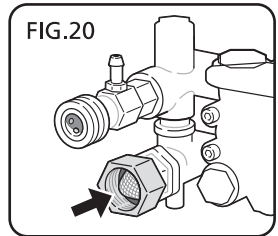

**WARNING: Do not operate pressure washer without screen filter in place. Impurities entering pressure pump can cause internal damage.**

# 11. MAINTENANCE

---

## 11.6 CLEANING PRESSURE WASHER

Daily or before use inspections should include areas around and underneath Pressure Washer looking for signs of fuel or oil leaks. Preventative maintenance should be taken if leaks are found. Clean accumulated debris from outside and inside Pressure Washer. Ensure all linkages, springs and other engine controls are kept clean. Inspect cooling air slots and openings on Pressure Washer. Openings must be kept clean and unobstructed for peak performance of Pressure Washer.

Engine components should be kept clean reducing risk of overheating and ignition of accumulated debris.

- Use a damp cloth to wipe exterior surfaces clean.
- Use a soft bristle brush to loosen caked on dirt or oil.

## 11.7 STORAGE

**WARNING: Petrol and petrol vapour are extremely flammable and explosive. Fire or explosion from misuse of fuel can cause severe burns or death.**

### ENGINE

Petrol can become stale when stored over 30 days. Stale fuel causes acid and gum deposits to form in the fuel system or crucial carburetor parts. Fuel should be removed if the machine is stored for prolonged period of time.

**NOTE: DO NOT** store petrol from one season to another unless it's been treated with fuel stabiliser.

Replace fuel container, if metal and if it begins to rust. Rust and dirt and debris can contaminate fuel supply and components resulting in poor performance and/or internal damage to engine. Petrol should be stored in newer approved plastic storage containers.

### TO PROTECT AGAINST RUST FORMATION DURING STORAGE, OIL THE CYLINDER BORE:

- Remove spark plug and pour approximately 15 ml of clean engine oil into the cylinder.
- Install spark plug and pull starter cord slowly to distribute oil.
- Make sure engine **ON/OFF** switch is **OFF**. Slowly pull the starter cord 2 to 3 times to distribute and coat the cylinder bore with oil. **DO NOT** start engine at this time.

**WARNING: Unintentional sparking can cause fire or electrical shock. Failure to observe this warning can cause severe property damage, severe burns and even death.**

**Disconnect spark plug wire from spark plug and cover tip of spark plug wire with insulating tape and place wire where it cannot come in contact with spark plug or pressure washer frame.**



# 11. MAINTENANCE

---

## ***PRESSURE PUMP***

1. Drain all water from pressure hose, coil and store it in cradle of pressure washer handle.
2. Drain all water from gun and lance by holding gun in vertical position with nozzle pointed downward. Squeeze trigger to remove fluids from spray gun and lance. Store in hose holder.
3. Store high pressure hose and lance so they are protected from damage, such as being run over.

It is **RECOMMENDED** that you follow these steps to protect the internal seals of Pressure Washer when storing unit for more than 30 days and/or when freezing temperatures are expected.

**CAUTION: Only use good quality premix automotive antifreeze. Neat antifreeze can damage seals and other key components.**

1. Add antifreeze using the funnel.
2. Make sure engine ON/OFF switch is OFF. Slowly pull engine starter cord several times until antifreeze comes out of pressure hose connection of pressure pump. **DO NOT** start engine at this time.

# 11. MAINTENANCE

---

## ***PRESSURE WASHER***

1. Cover Pressure Washer with a suitable cover that does not retain moisture such as a plastic or plastic coated tarp.
2. Store Pressure Washer in a clean, dry area.

**WARNING: Certain storage covers can be flammable or can melt in higher temperatures.** Do not place storage cover over pressure washer unit until it has completely cooled.

## ***11.8 PREPARING FOR USE AFTER STORAGE***

1. Slowly pull the Starter cord a few times to clean oil from the cylinder or to eject any antifreeze from the pump which were added prior to storage.
2. Remove the spark plug from the cylinder. Wipe oil from the spark plug and return it to the cylinder and retighten.
3. Reconnect the spark plug wire.

## 12. TROUBLESHOOTING

### 12.1 TROUBLESHOOTING GUIDE

<b>Problem</b>	<b>Probable Cause</b>	<b>Solution</b>
Engine shuts down when running.	<ol style="list-style-type: none"><li>1. Out of fuel.</li><li>2. Low Engine Oil</li></ol>	<ol style="list-style-type: none"><li>1. Fill fuel tank.</li><li>2. Add oil.</li></ol>
Engine will not start; or starts and runs rough.	<ol style="list-style-type: none"><li>1. Engine On/Off set to "OFF" position.</li><li>2. Fuel valve is in "OFF" position.</li><li>3. Dirty air cleaner.</li><li>4. Out of fuel.</li><li>5. Stale fuel.</li><li>6. Spark plug wire not connected to spark plug.</li><li>7. Bad spark plug.</li><li>8. Water in fuel.</li><li>9. Flooded.</li><li>10. Excessively rich fuel/air mixture.</li><li>11. Intake valve stuck open or closed.</li><li>12. Engine has lost compression.</li><li>13. Low engine oil.</li><li>14. Wrong Fuel.</li><li>15. Engine is too hot</li><li>16. Chock is in wrong position</li><li>17. Pressure builds up after 2 pulls on starter coil or after initial use.</li></ol>	<ol style="list-style-type: none"><li>1. Set switch to "ON" position.</li><li>2. Turn fuel valve to "ON" position.</li><li>3. Clean or replace air cleaner.</li><li>4. Fill fuel tank.</li><li>5. Drain fuel tank and carburetor; fill with fresh fuel.</li><li>6. Connect wire to spark plug.</li><li>7. Replace spark plug.</li><li>8. Drain fuel tank and carburetor; fill with fresh fuel.</li><li>9. Wait 5 minutes and re-crank engine.</li><li>10. Call Draper.</li><li>11. Call Draper.</li><li>12. Call Draper.</li><li>13. Add oil.</li><li>14. Use recommended fuel.</li><li>15. Allow engine to cool</li><li>16. Change chock position</li><li>17. Squeeze gun trigger to relieve pressure.</li></ol>

## 12. TROUBLESHOOTING

Problem	Probable Cause	Solution
Engine “hunts” or falters.	1. Carburetor is running too rich or too lean.	1. Call Draper.
Engine lacks power.	1. Cylinder pressure is low. 2. Dirty air cleaner.	1. Call Draper. 2. Replace air filter.
No pressure or Low pressure.	1. Spray wand not set to high pressure. 2. Inadequate water supply. 3. Hose fitting leaks during high pressure. 4. Nozzle obstructed. 5. Water filter screen obstructed. 6. Defective pump  7. Air in hose. 8. Choke lever in choke position. 9. Throttle control lever is hot in fast position.	1. See “SELECTING THE RIGHT NOZZLE” section. 2. Water supply must be 5 GPM @ 20 psi. 3. Tighten hose fitting. Use thread sealant tape if necessary. 4. Clean Nozzle (See Maintenance) 5. Remove and clean filter. 6. Call Draper.  7. Squeeze trigger to remove air. 8. Move choke to “RUN” position. 9. Move throttle control lever from fast position.
Water leaking at pump.	1. Loose connections. 2. Piston packings worn.  3. Worn or broken O-rings.  4. Pump head or tubes damaged from freezing.	1. Tighten connections. 2. Clean or replace. Call Draper.  3. Clean or replace. Call Call Draper.  4. Clean or replace. Call Call Draper.

## 12. TROUBLESHOOTING

Problem	Probable Cause	Solution
Pump will not draw chemicals.	<ol style="list-style-type: none"> <li>1. Spray wand not set to low pressure.</li> <li>2. Chemical hose/filter clogged.</li> <li>3. Chemical screen not in chemical.</li> <li>4. Chemical solution too thick.</li> <li>5. Chemical build-up in chemical injector.</li> </ol>	<ol style="list-style-type: none"> <li>1. See "SELECTING THE RIGHT NOZZLE" section.</li> <li>2. Clean hose/filter.</li> <li>3. Ensure end of chemical hose is fully submerged into chemicals.</li> <li>4. Dilute chemical. Chemical solutions should have same consistency as water.</li> <li>5. Clean or replace. Call Draper.</li> </ol>
No or low pressure (after period of normal use).	<ol style="list-style-type: none"> <li>1. Worn seal or packing.</li> <li>2. Worn or obstructed valves.</li> <li>3. Worn unloader piston.</li> </ol>	Clean or replace. Call Draper.
Water leaking at spray gun/spray wand connection.	<ol style="list-style-type: none"> <li>1. Worn or broken O-ring.</li> <li>2. Loose hose connection.</li> </ol>	<ol style="list-style-type: none"> <li>1. Worn or broken O-ring.</li> <li>2. Tighten hose connection.</li> </ol>
Oil leaking at pump	<ol style="list-style-type: none"> <li>1. Oil seals worn.</li> <li>2. Loose drain plug.</li> <li>3. Worn drain plug O-ring.</li> <li>4. Worn fill plug O-ring.</li> <li>5. Pump overfilled.</li> <li>6. Incorrect oil used.</li> <li>7. Vent plug clogged.</li> </ol>	<ol style="list-style-type: none"> <li>1. Clean or replace. Call Draper.</li> <li>2. Tighten drain plug.</li> <li>3. Inspect &amp; replace O-ring.</li> <li>4. Inspect &amp; replace O-ring.</li> <li>5. Check for correct amount.</li> <li>6. Drain and refill with correct type and amount of oil.</li> <li>7. Clean vent plug. Use air hose to free it of blockage. If problem persists, replace vent plug.</li> </ol>

## 12. TROUBLESHOOTING

Problem	Probable Cause	Solution
Pump pulsates	1. Nozzle obstructed. 2. Air in the system	1. Clean Nozzle (See Maintenance) 2. Squeeze trigger to remove air.

### GENERAL INFO:

Petrol	<ul style="list-style-type: none"><li>• Use fresh high quality unleaded petrol.</li></ul>
Oil	<ul style="list-style-type: none"><li>• Engine oil: Use oil as described on page 15.</li></ul>
Water	<ul style="list-style-type: none"><li>• Use only cold water.</li><li>• Do not operate pressure washer with clogged or missing water filter screen.</li><li>• Do not operate pressure washer without adequate water supply to pressure pump. Adequate water supply is a minimum of 20 PSI @ 19L/m.</li></ul>
Pressure Adjustment	<ul style="list-style-type: none"><li>• Pressure setting is preset at factory.</li></ul>
Pump	<ul style="list-style-type: none"><li>• Squeeze spray gun trigger every 2 minutes while engine is running.</li><li>• Do not allow water to freeze in pump.</li></ul>
By-Pass Mode	<ul style="list-style-type: none"><li>• Never leave unit running for more than 2 minutes without squeezing spray gun trigger. Doing so could damage pump and void warranty.</li></ul>
*Optional Spare Parts	<ul style="list-style-type: none"><li>• Pump is equipped with a thermal relief valve. If water overheats, this valve opens releasing gush of water. Afterwards, the valve closes returning pump to normal operation.</li></ul>

## 12. TROUBLESHOOTING

---

Hose	<ul style="list-style-type: none"><li>• Do not allow hoses to come in contact with engine muffler during or immediately after use.</li><li>• DO NOT pull unit by pressure hose.</li></ul>
Engine	<ul style="list-style-type: none"><li>• Do not adjust or attempt maintenance without consulting authorised Draper service centre.</li><li>• Always turn on water before starting engine.</li></ul>
Soap/Chemicals	<ul style="list-style-type: none"><li>• Use only soaps and chemical detergents designed for pressure washer use.</li><li>• Use Chemical nozzle (Black) with Soap/Chemicals.</li></ul>
Nozzle	<ul style="list-style-type: none"><li>• Always keep nozzles unclogged.</li><li>• Chemical/soap solutions cannot be applied using high pressure setting. Set pressure pump to low pressure and use low pressure nozzle.</li></ul>
Storage or Winterizing	<ul style="list-style-type: none"><li>• Run clean water through chemical inlet.</li><li>• Do not allow water to freeze in pressure pump, spray gun, spray wand or hoses.</li></ul>

## 13. DISPOSAL

---

### 13.1 DISPOSAL

- At the end of the machine's working life, or when it can no longer be repaired, ensure that it is disposed of according to national regulations.
- Contact your local authority for details of collection schemes in your area.

In all circumstances:

- Do not dispose of power tools with domestic waste.
- Do not incinerate.
- Do not abandon in the environment.
- Do not dispose of WEEE\* as unsorted municipal waste.



\* Waste Electrical & Electronic Equipment.

- **DRAPER TOOLS LIMITED,**  
Hursley Road, Chandler's Ford,  
Eastleigh, Hampshire. SO53 1YF. U.K.
- **Helpline:** (023) 8049 4344
- **Sales Desk:** (023) 8049 4333
- **General Enquiries:** (023) 8026 6355
- **Service/Warranty Repair Agent**  
For aftersales servicing or warranty repairs, please  
contact the Draper Tools Helpline for details of an  
agent in your local area.

YOUR DRAPER STOCKIST

DKDH1215

